

NOTES

INSTRUMENT LOCATION LAYOUT

LEGEND

REFERENCE DRAWING DRG. No.

KEY PLAN

REV.	DATE	DESCRIPTION	CHECKED BY	DATE	REV. APPR. BY	DATE
000	AC11/2022	IPC	Phalqamajhi	MURSHID	MURSHID	** **
REV.	DATE	FOIIS	PREP.	CHK.	APP.	AUT.

PROJECT NAME: BINAK OILFIELD DEVELOPMENT/SURFACE FACILITIES
GAS COMPRESSOR STATION

PROJECT NO.: 971020

EPC CONTRACTOR: HIRGAN ENERGY - DESIGN & INSPECTION COMPANIES

EPD/EPC CONTRACTOR (GC): PETROIRAN DEVELOPMENT COMPANY

NO CONSTRUCTION PERMITTED UNLESS DRAWING APPROVED

APPROVED FOR CONSTRUCTION BY: DATE: BUDGET REF. LOCATION SIZE CLASS SERIAL NO. SHEET NO. OF 19

DATE SCALE DRAWING BY CHECKED BY PROJECT ENG.

SCALE	SIZE	DRAWING NO.	SHEET NO.	REV.	BUDGET REF.	LOCATION	SIZE CLASS	SERIAL NO.	SHEET NO.	OF 19	REVISION
N.T.S	A3	BR-GCS-PDCCO-120-IN-PY-0003	01 OF 19	000	0-63-073-9184	F	2	J	709998	01 OF 19	000

(VENDOR TITLE BLOCK)**

RECORD SHEET

Page	Rev.				Page	Rev.			
	D00	D01	D02	D03		D00	D01	D02	D03
1	X				36				
2	X				37				
3	X				38				
4	X				39				
5	X				40				
6	X				41				
7	X				42				
8	X				43				
9	X				44				
10	X				45				
11	X				46				
12	X				47				
13	X				48				
14	X				49				
15	X				50				
16	X				51				
17	X				52				
18	X				53				
19	X				54				
20					55				
21					56				
22					57				
23					58				
24					59				
25					60				
26					61				
27					62				
28					63				
29					64				
30					65				
31					66				
32					67				
33					68				
34					69				
35					70				

Page	Rev.	D00	D01	D02	D03	D04
71						
72						
73						
74						
75						
76						
77						
78						
79						
80						
81						
82						
83						
84						
85						
86						
87						
88						
89						
90						
91						
92						
93						
94						
95						
96						
97						
98						
99						
100						
101						
102						
103						
104						
105						

REV.	DATE	DESCRIPTION	CHECKED BY	DATE	REV.	DATE	DESCRIPTION
***	*****	*****	***	*****	***	*****	*****
***	*****	*****	***	*****	***	*****	*****

EPC CONTRACTOR:  HIRGAN ENERGY - DESIGN & INSPECTION COMPANIES	EMD/EPC CONTRACTOR (GC):  PETROBRAN DEVELOPMENT COMPANY
--	---

PROJECT NAME: BINAK OILFIELD DEVELOPMENT/SURFACE FACILITIES GAS COMPRESSOR STATION	PROJECT NO.: 971020	DRAWING TITLE: INSTRUMENT LOCATION LAYOUT	SCALE: A3	SHEET NO. 02 OF 19	REV. D00
---	------------------------	--	--------------	-----------------------	-------------

NO CONSTRUCTION PERMITTED UNLESS DRAWING APPROVED APPROVED FOR CONSTRUCTION BY:	DATE:
--	-------

THE ORIGINAL AND ALL COPIES OF THIS DRAWING TOGETHER WITH THE COPYRIGHT THEREIN ARE THE SOLE PROPERTY OF N.I.S.O.C./ FIELDS	DRC. No.
---	----------

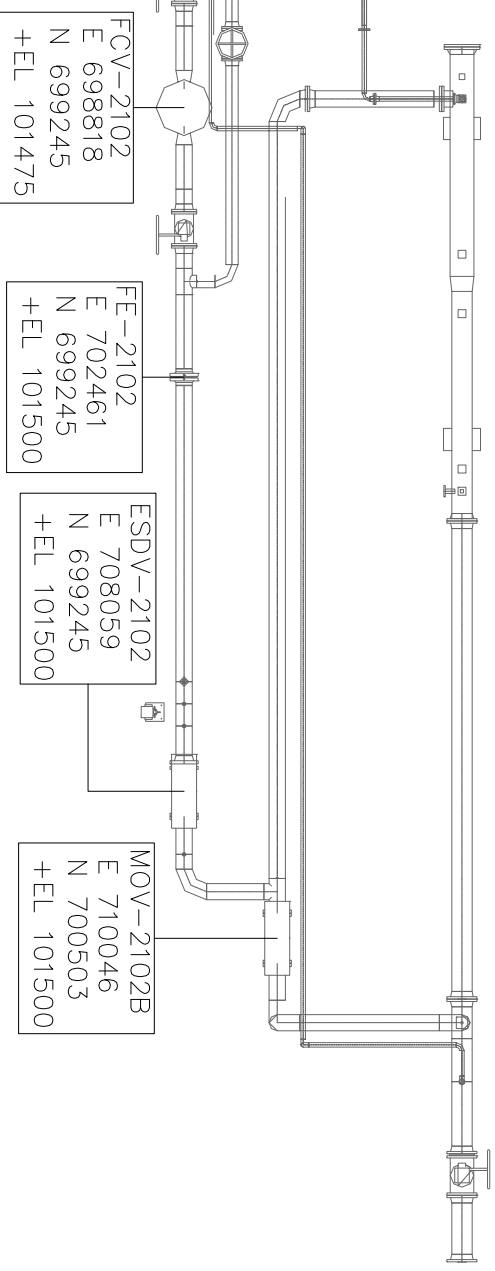
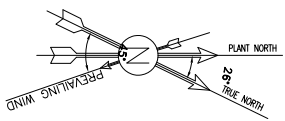

PRV-2272
E 696817
N 689148
+EL 101445

FCV-2102
E 698818
N 699245
+EL 101475

FE-2102
E 702461
N 699245
+EL 101500

ESDV-2102
E 708059
N 699245
+EL 101500

MOV-2102B
E 710046
N 700503
+EL 101500

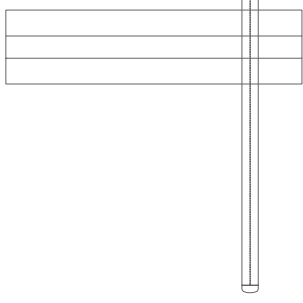

REV.	DESCRIPTION	BY	DATE	CHECKED	BY	DATE	REV. APPR.
***	*****	**	****	**	**	****	***

DOO	DATE	REV.	DESCRIPTION
DOO	03/12/2022	01	ISSUED FOR PERMIT

NO CONSTRUCTION PERMITTED UNLESS DRAWING APPROVED
APPROVED FOR CONSTRUCTION BY: DATE:
BUDGET REF. LOCATION SIZE CLASS SERIAL NO. SHEET REVISION
0-65-073-0184 F 2 J 709998 03 OF 19 DOO

HIRSANY
HIRSANY ENERGY - DESIGN & INSPECTION COMPANIES

PETROBRAN
DEVELOPMENT COMPANY

PD/PC CONTRACTOR (GC):
BINA K OILFIELD DEVELOPMENT SURFACE FACILITIES GAS COMPRESSOR STATION

PROJECT NAME: BINA K OILFIELD DEVELOPMENT/SURFACE FACILITIES GAS COMPRESSOR STATION

PROJECT NO.: 971020

SCALE: AS

SIZE: BR-GCS-PDCC-120-IN-PY-0003

SHEET NO.: 03 OF 19

REV.: DOO

(VENDOR TITLE BLOCK)**

NOTES

REFERENCE DRAWING DRG. No.

LEGEND

THIS AREA

KEY PLAN

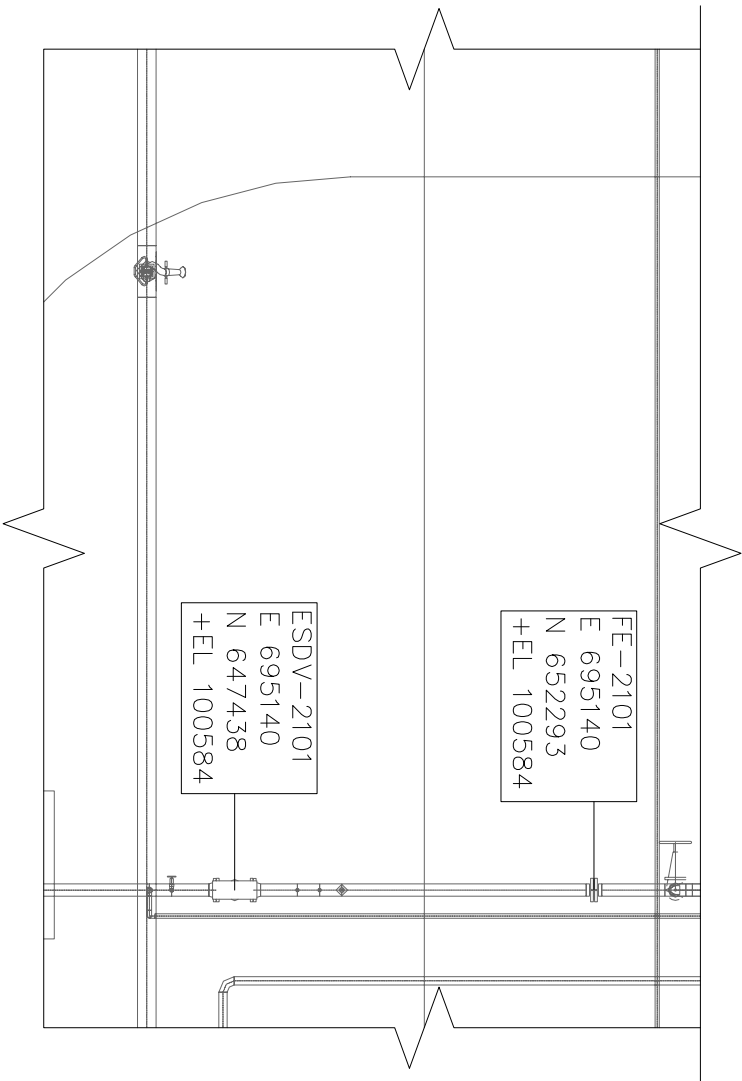
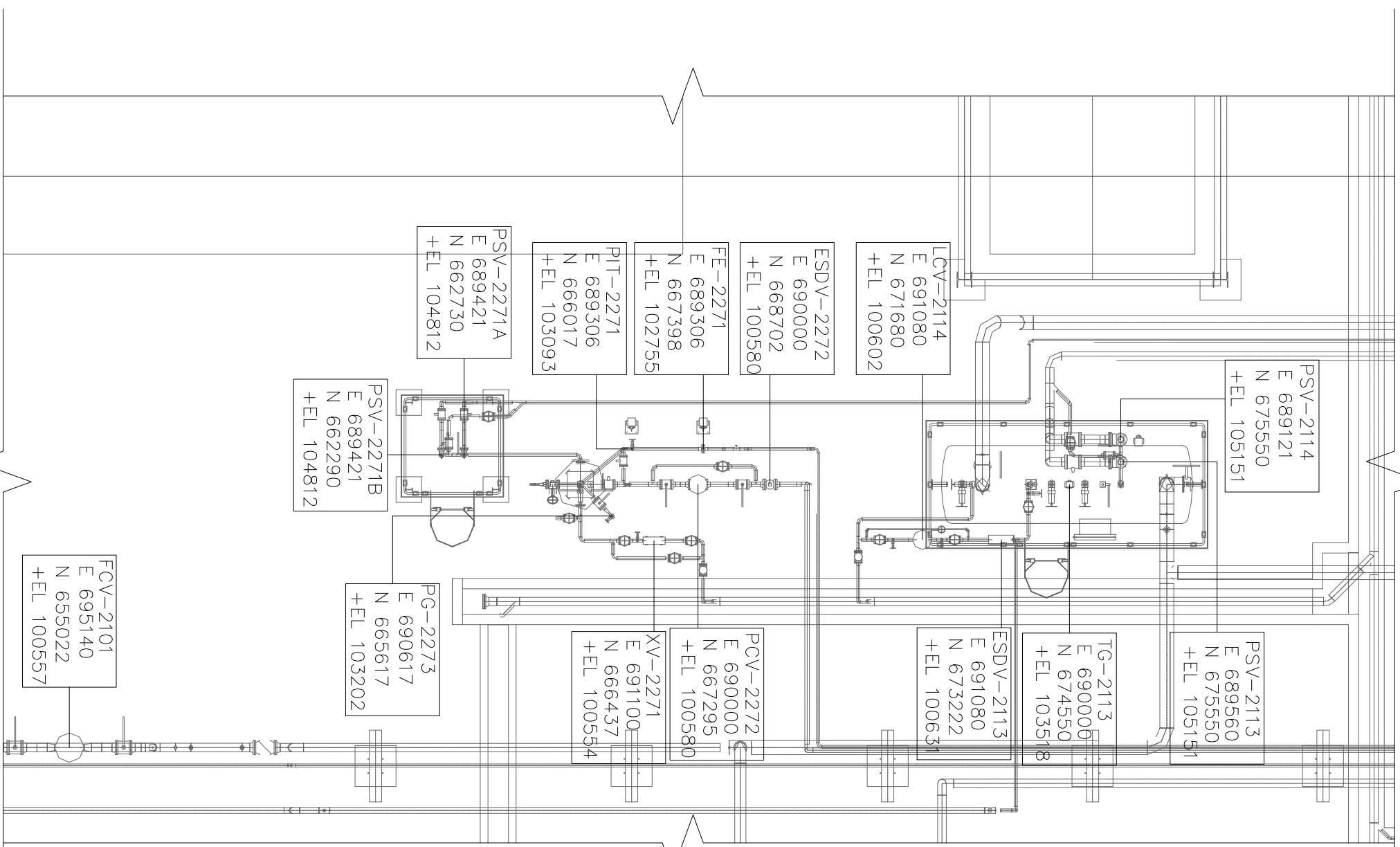
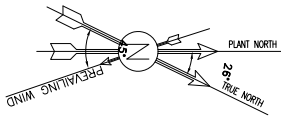

NOTES

LEGEND

REFERENCE DRAWING DRG. No.

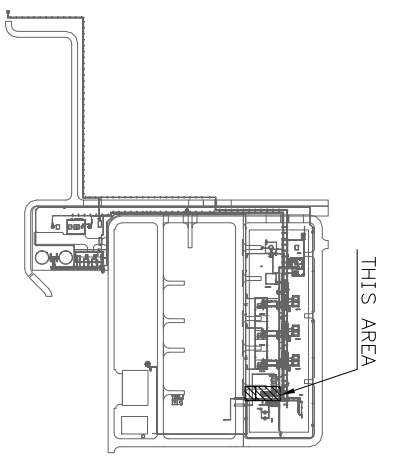

KEY PLAN

REV.	DATE	DESCRIPTION	CHECKED BY	DATE	APPR. BY	DATE
***	*****	*****	***	*****	***	*****

THE ORIGINAL AND ALL COPIES OF THIS DRAWING TOGETHER WITH THE COPYRIGHT THEREIN ARE THE SOLE PROPERTY OF N.I.S.O.C./ FIELDS

EPC CONTRACTOR: HIRSHAN ENERGY - DESIGN & INSPECTION
EPD/EPC CONTRACTOR (GC): PETROBRAN DEVELOPMENT COMPANY
PROJECT NAME: BINAK OILFIELD DEVELOPMENT/SURFACE FACILITIES GAS COMPRESSOR STATION
PROJECT NO.: 971020

SCALE	SIZE	DRAWING NO.	SHEET NO.	REV.	DATE
N.T.S	A3	BR-GCS-PDCO-120-JR-PY-0003	06 OF 19	000	01 OF 19

DRAWING TITLE: INSTRUMENT LOCATION LAYOUT
APPROVED FOR CONSTRUCTION BY: [Signature]
DATE: 01 OF 19

(VENDOR TITLE BLOCK)**

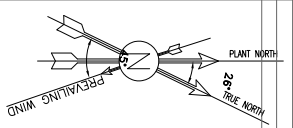

RO-2131A
E 656338
N 679819
+EL 100684

XV-2131A
E 657035
N 679819
+EL 100687

BDV-2134A
E 658553
N 678321
+EL 105086

RO-2134A
E 658257
N 679074
+EL 105086

FIT-2131A
E 656250
N 672270
+EL 100884

FIT-2121A
E 661750
N 672270
+EL 100910

XV-2122A
E 664915
N 679819
+EL 100831

RO-2121A
E 665611
N 679819
+EL 100828

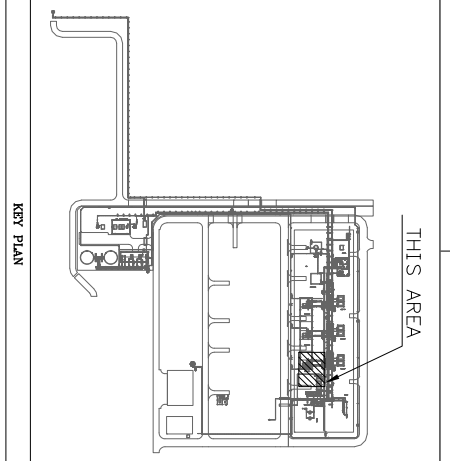
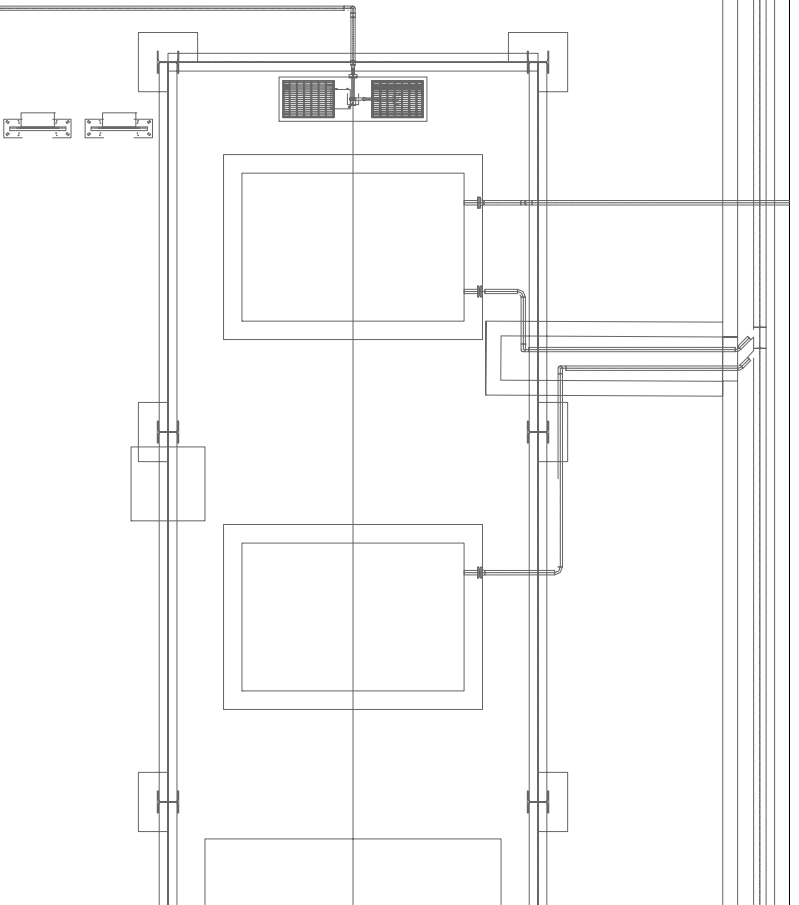
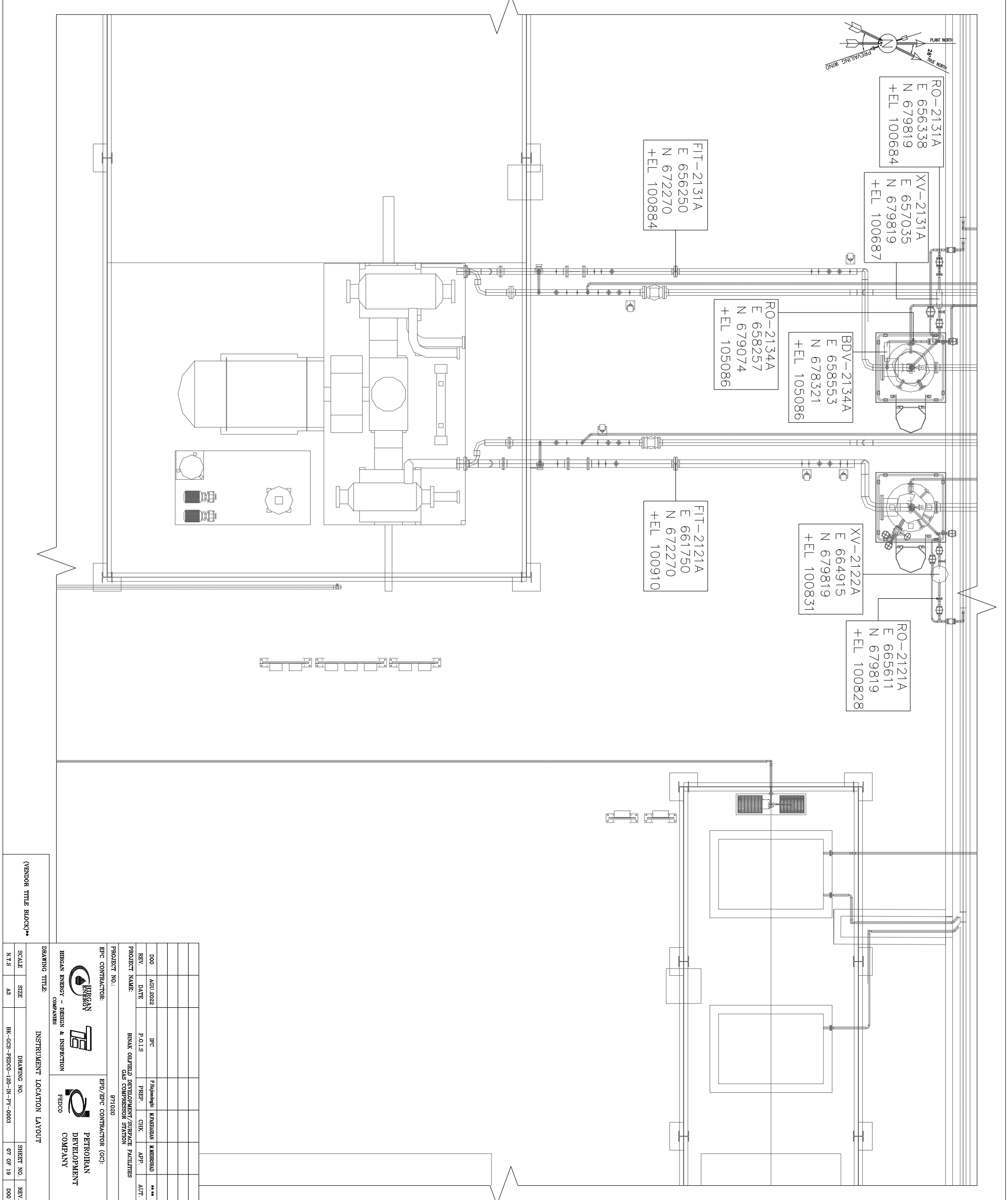

NOTES

LEGEND

REFERENCE DRAWING DRG. No.

KEY PLAN

THIS AREA

NO CONSTRUCTION PERMITTED UNLESS DRAWING APPROVED

APPROVED FOR CONSTRUCTION BY: DATE:

BUDGET REF. LOCATION SIZE CLASS SERIAL NO. SHEET REVISION

0-65-073-9184 F 2 J 709998 01 OF 19 D00

REV.	DESCRIPTION	BY	DATE	CHECKED	BY	DATE	REV. APPR.	DATE
***	*****	**	****	**	**	****	***	****

PROJECT NAME: BINAK OILFIELD DEVELOPMENT/SURFACE FACILITIES

PROJECT NO.: 971020

EPC CONTRACTOR: EHD/EPC CONTRACTOR (GC)

HIRGAN ENERGY - DESIGN & INSPECTION

PHILIPINE PETROLEUM DEVELOPMENT COMPANY

INSTRUMENT LOCATION LAYOUT

DRAWING TITLE:

SCALE: AS

SIZE: A3

N.T.S.

BR-GCS-PDCO-120-JR-PY-0003

07 OF 19

SHEET NO. D00

DATE: 01 OF 19

REVISION: D00

709998

01 OF 19

D00

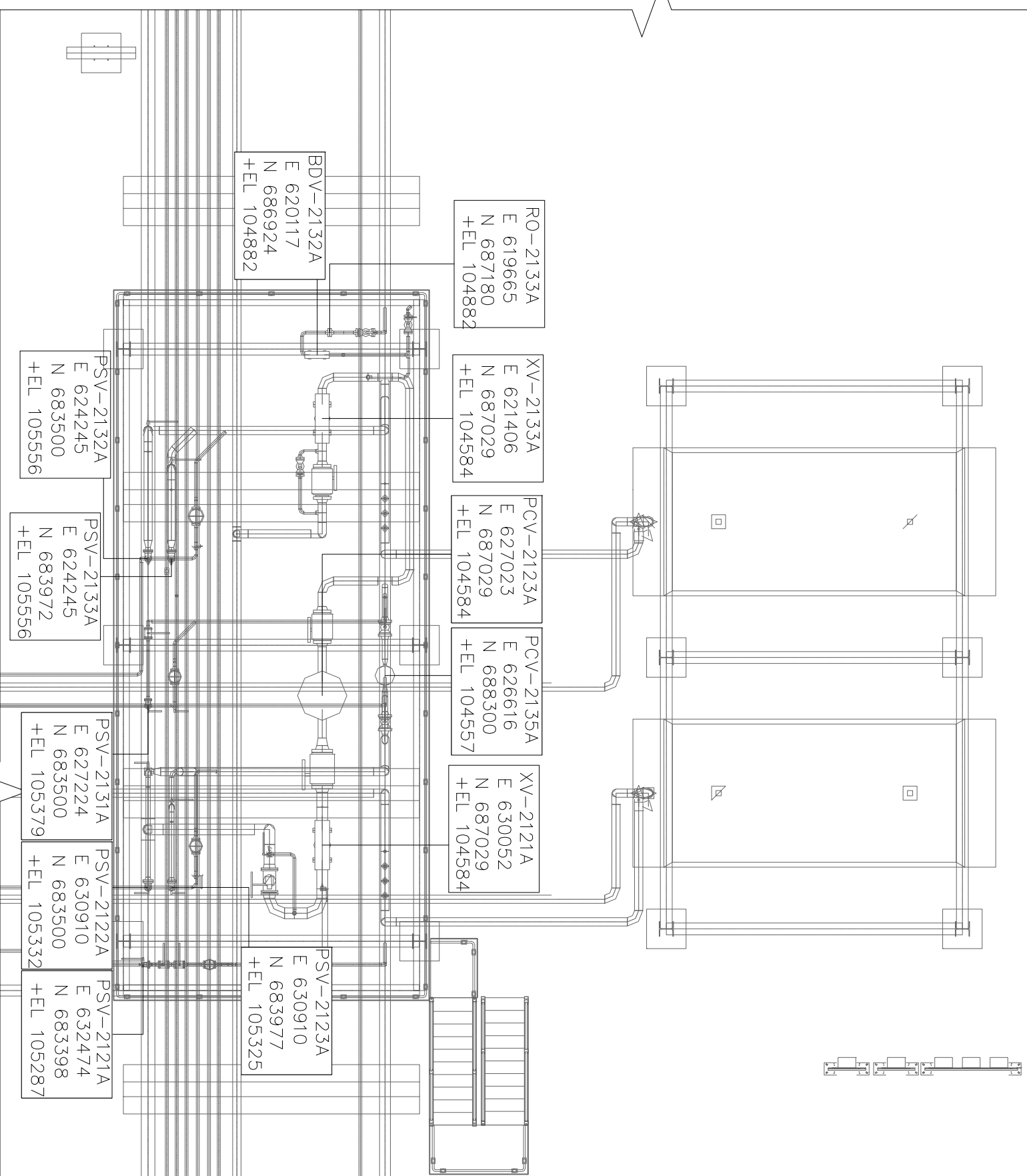
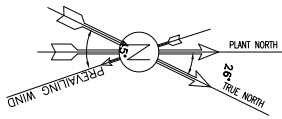

NOTES

REFERENCE DRAWING DRG. No.

LEGEND

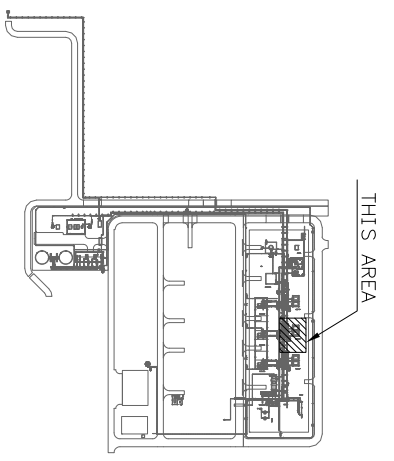

KEY PLAN

REV.	DESCRIPTION	BY	DATE	CHECKED	BY	DATE	REV. APPR.	DATE
***	*****	**	****	***	**	****	***	****

THE ORIGINAL AND ALL COPIES OF THIS DRAWING TOGETHER WITH THE COPYRIGHT THEREIN ARE THE SOLE PROPERTY OF N.I.S.O.C./ FIELDS

PROJECT NAME: BINAK OILFIELD DEVELOPMENT/SURFACE FACILITIES GAS COMPRESSOR STATION PROJECT NO.: 971020		EPC CONTRACTOR: HIRSHAN ENERGY - DESIGN & INSPECTION COMPANIES HIRSHAN ENERGY - DESIGN & INSPECTION COMPANIES		EPC CONTRACTOR (GC): PETROBRAN DEVELOPMENT COMPANY PETROBRAN DEVELOPMENT COMPANY	
DOO ACI 2022	IPC P.O.I.S	PREP. P.H.A.M.A.H	CHK. C.H.K.	APP. A.P.P.	AUT. A.U.T.
SCALE N.T.S	SIZE A3	DRAWING NO. BR-GCS-PDCO-120-JR-PY-0003	SHEET NO. 08 OF 19	REV. D00	APPROVED FOR CONSTRUCTION BY: _____ DATE: _____ BUDGET REP. LOCATION SIZE CLASS SERIAL NO. 709998 01 OF 19 D00

(VENDOR TITLE BLOCK)**

DRAWING TITLE: INSTRUMENT LOCATION LAYOUT
 NO CONSTRUCTION PERMITTED UNLESS DRAWING APPROVED

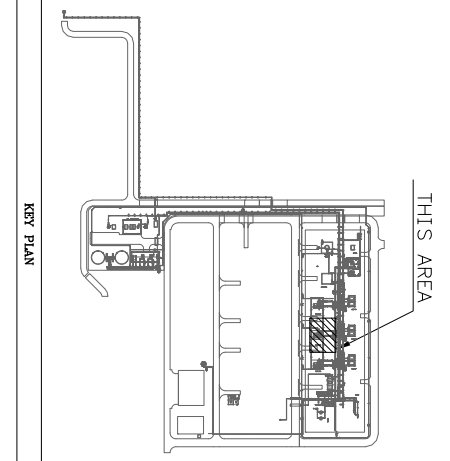
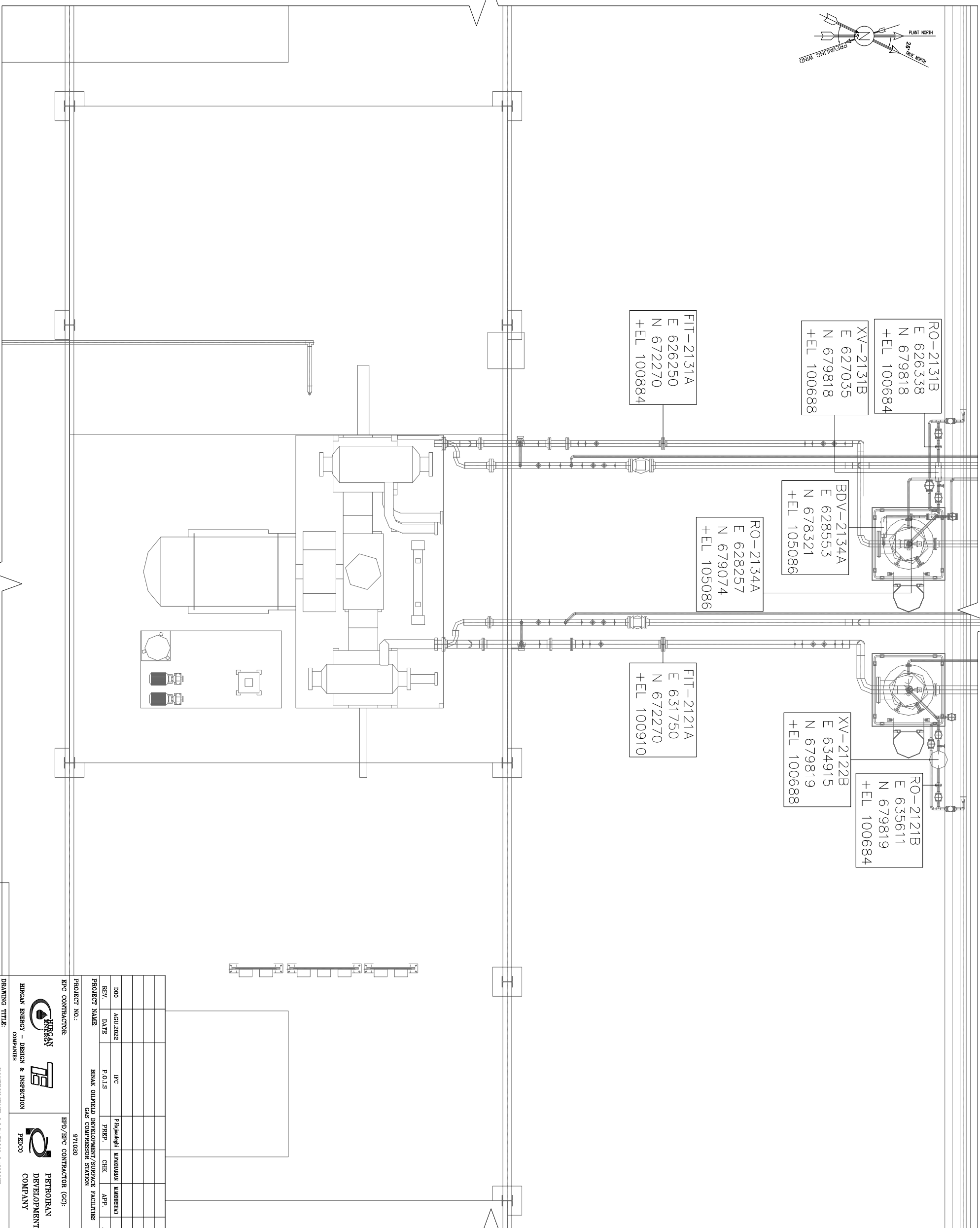
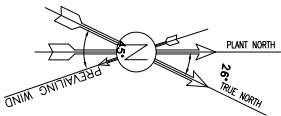

NOTES

LEGEND

REFERENCE DRAWING DRG. No.

REV.	DESCRIPTION	BY	DATE	CHECKED	BY	DATE
***	*****	**	****	**	**	****
***	*****	**	****	**	**	****

THE ORIGINAL AND ALL COPIES OF THIS DRAWING TOGETHER WITH THE COPYRIGHT THEREIN ARE THE SOLE PROPERTY OF N.I.S.O.C./ FIELDS

EPC CONTRACTOR: 		EHP/EPC CONTRACTOR (GC): 	
PROJECT NAME: BINAK OILFIELD DEVELOPMENT/SURFACE FACILITIES GAS COMPRESSOR STATION		PROJECT NO.: 971020	
REV. DATE		APPR. DATE	
DATE		DATE	

DRAWING TITLE: INSTRUMENT LOCATION LAYOUT			
SCALE	SIZE	DRAWING NO.	SHEET NO.
N.T.S	A3	BR-GCS-PDCO-120-JR-PY-0003	09 OF 19
APPROVED FOR CONSTRUCTION		DATE:	
BUDGET REF LOCATION SIZE CLASS SERIAL NO. 709998		01 OF 19	

(VENDOR TITLE BLOCK)**

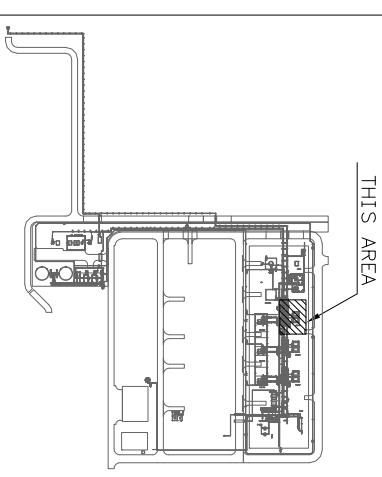
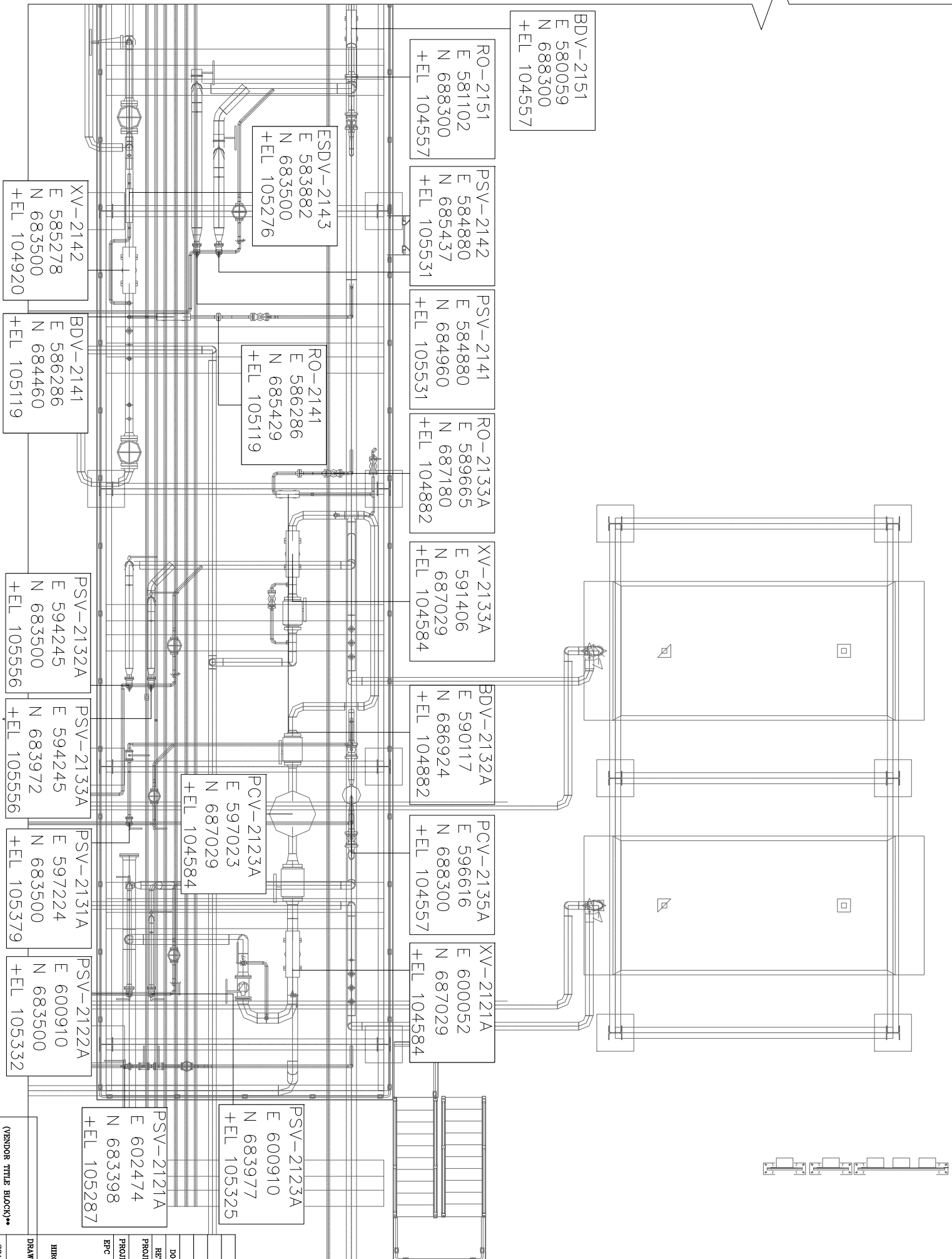
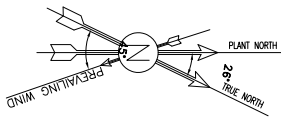

NOTES

REFERENCE DRAWING

DRG. No.

LEGEND

REV.	DESCRIPTION	BY	DATE	CHECKED	BY	DATE	REV. APPR.	DATE
***	*****	**	****	****	**	****	****	****

THE ORIGINAL AND ALL COPIES OF THIS DRAWING TOGETHER WITH THE COPYRIGHT THEREIN ARE THE SOLE PROPERTY OF N.I.S.O.C./ FIELDS

HIRSOGAN HIRSON ENERGY - DESIGN & INSPECTION COMPANIES		PDICO EPC CONTRACTOR (GC)		PETROBRAS DEVELOPMENT COMPANY	
PROJECT NAME: BINAK OILFIELD DEVELOPMENT/SURFACE FACILITIES GAS COMPRESSOR STATION		PROJECT NO.: 971020		NO CONSTRUCTION PERMITTED UNLESS DRAWING APPROVED	
DRAWING TITLE: INSTRUMENT LOCATION LAYOUT		DRAWING NO.		APPROVED FOR CONSTRUCTION BY:	
SCALE: A3		BR-GCS-PDICO-120-JN-PT-0003		SHEET NO. 10 OF 19	
N.T.S		10 OF 19		REV. D00	
BUDGET REF. LOCATION SIZE CLASS		SERIAL NO. 709998		SHEET 01 OF 19	
F		2		J	
01 OF 19		709998		D00	

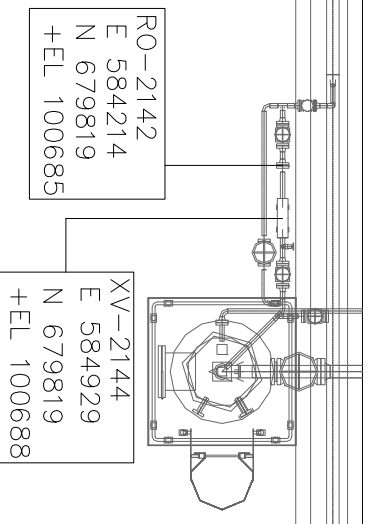
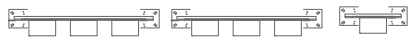
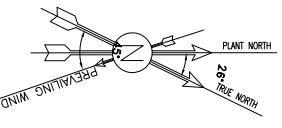

RO-2142
E 584214
N 679819
+EL 100685

XV-2144
E 584929
N 679819
+EL 100688

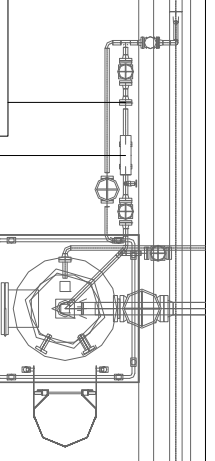

RO-2131C
E 596338
N 679818
+EL 100684

XV-2131C
E 597035
N 679818
+EL 100688

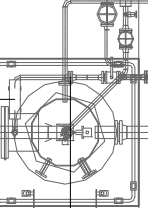

BDV-2134A
E 598553
N 678321
+EL 105086

RO-2134A
E 598257
N 679074
+EL 105086

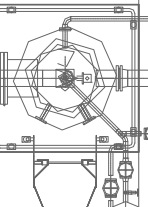

XV-2122C
E 604915
N 679818
+EL 100687

FIT-2121A
E 601750
N 672270
+EL 100910

RO-2121C
E 605611
N 679818
+EL 100684

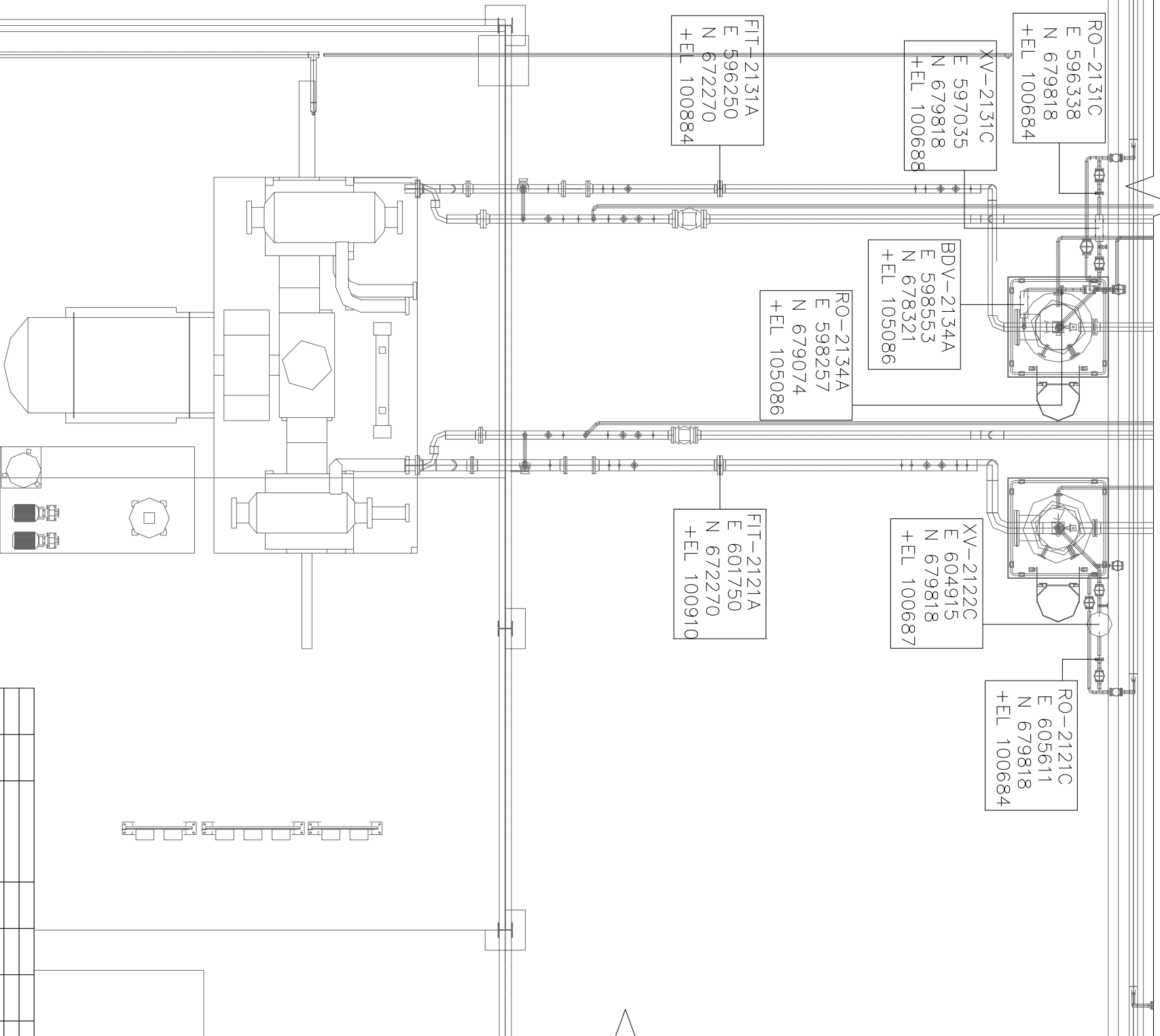

THIS AREA

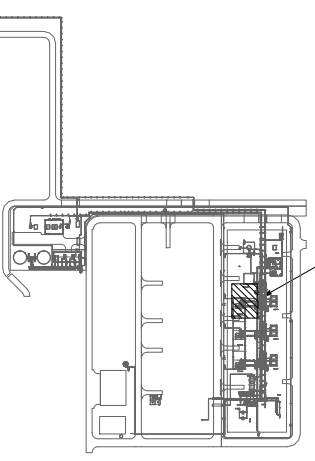

KEY PLAN

NOTES

REFERENCE DRAWING

DRG. No.

LEGEND

REV.	DATE	DESCRIPTION	BY	DATE	BY	DATE
000	01/2022	IFC				
		FOR I/S				
		PREP.				
		CHK.				
		APP.				
		AUT.				

PROJECT NAME:

BINAK OILFIELD DEVELOPMENT/SURFACE FACILITIES

GAS COMPRESSOR STATION

PROJECT NO.:

971020

EPC CONTRACTOR:

HIRGAN

ENERGY & DESIGN & INSPECTION COMPANIES

PD/PC CONTRACTOR (GC):

PETROBRAN DEVELOPMENT COMPANY

DATE

SCALE

DRAWING BY

CHECKED BY

PROJECT ENG.

NO CONSTRUCTION PERMITTED UNLESS DRAWING APPROVED

APPROVED FOR CONSTRUCTION BY:

DATE:

BUDGET REF. LOCATION SIZE CLASS SERIAL NO. SHEET REVISION

0-65-073-0184 F 2 J 709998 01 OF 19 D00

DRAWING TITLE:

INSTRUMENT LOCATION LAYOUT

DRAWING NO. SHEET NO. REV.

BR-GCS-PDCO-120-JR-PY-0003 11 OF 19 D00

SCALE SIZE

N.T.S. A3

(VENDOR TITLE BLOCK)**

NOTES

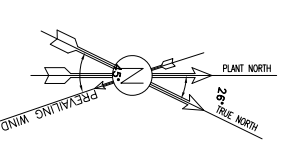

PG-2222A
E 569552
N 704721
+EL 97427

PG-2222B
E 569552
N 703721
+EL 97427

PCV-2152
E 578643
N 685788
+EL 104530

PCV-2151
E 572020
N 683500
+EL 100544

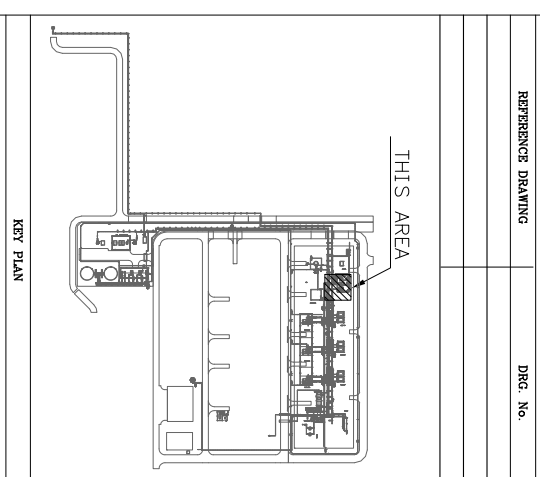
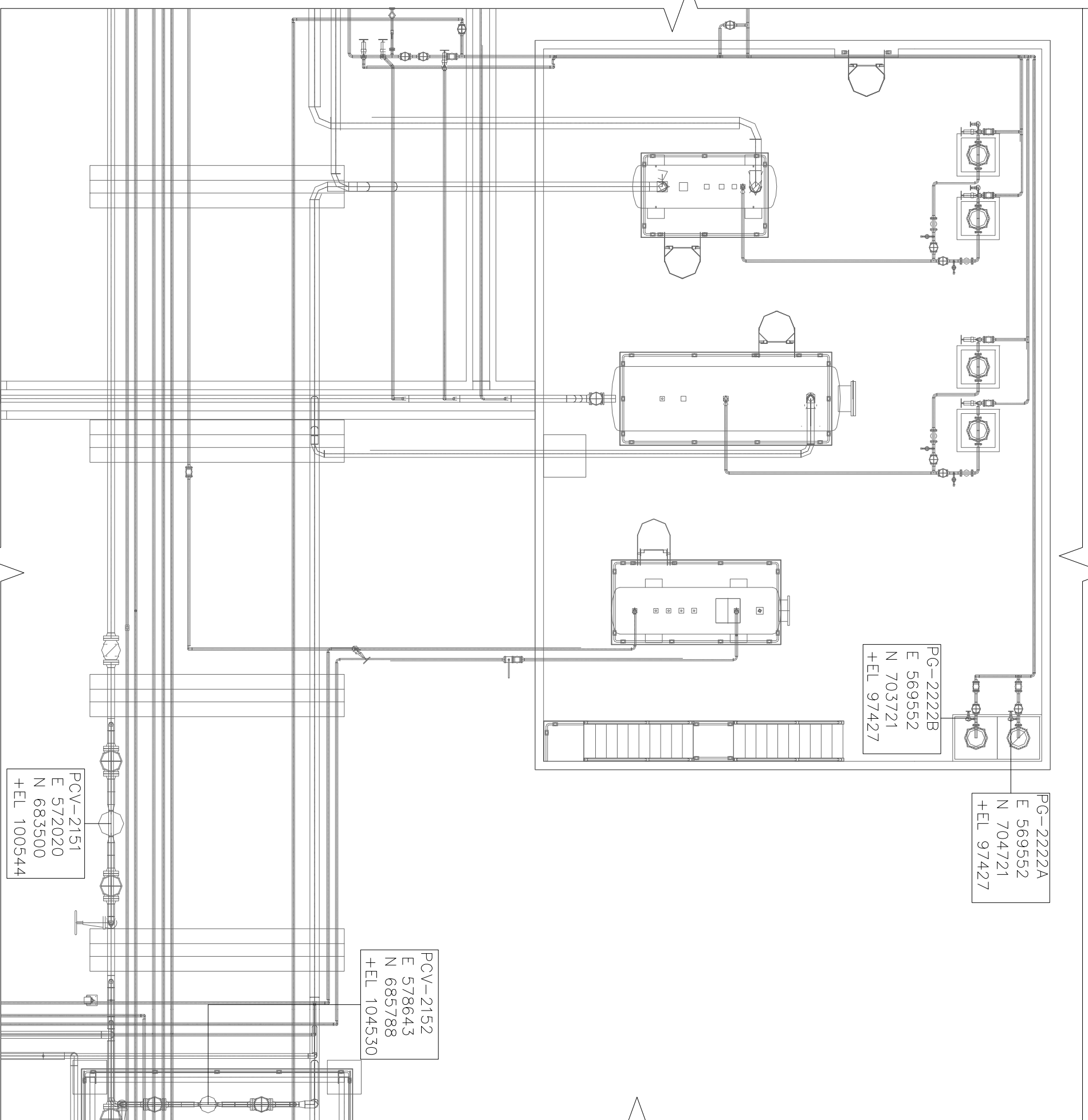

REFERENCE DRAWING

DRG. No.

LEGEND

REV.	DESCRIPTION	BY	DATE	CHECKED	BY	DATE	REV. APPR.	DATE
***	*****	**	****	**	**	****	**	****

DESCRIPTION

BY

DATE

CHECKED

BY

DATE

REV. APPR.

DATE

THE ORIGINAL AND ALL COPIES OF THIS DRAWING TOGETHER WITH THE COPYRIGHT THEREIN ARE THE SOLE PROPERTY OF N.I.S.O.C./ FIELDS

EPC CONTRACTOR: BHP/BJC CONTRACTOR (GC)

DESIGNER: HIRSHAN ENERGY - DESIGN & INSPECTION

INSPECTOR: PEDCO

DEVELOPER: PETROBRAN DEVELOPMENT COMPANY

PROJECT NAME: BINAK OILFIELD DEVELOPMENT/SURFACE FACILITIES GAS COMPRESSOR STATION

PROJECT NO.: 971020

DATE: 01/20/2022

SCALE: A3

DRAWING NO.: BR-GCS-PDCO-120-JR-PY-0003

SHEET NO.: 12 OF 19

REV.:

NO CONSTRUCTION PERMITTED UNLESS DRAWING APPROVED

APPROVED FOR CONSTRUCTION BY: DATE:

BUDGET REF. LOCATION SIZE CLASS SERIAL NO. SHEET REVISION

0-53-073-9184 F 2 J 709998 01 OF 19 D00

(VENDOR TITLE BLOCK)**

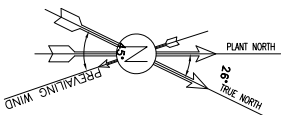

ESDV-3201
 E 532443
 N 703517
 +EL 101473

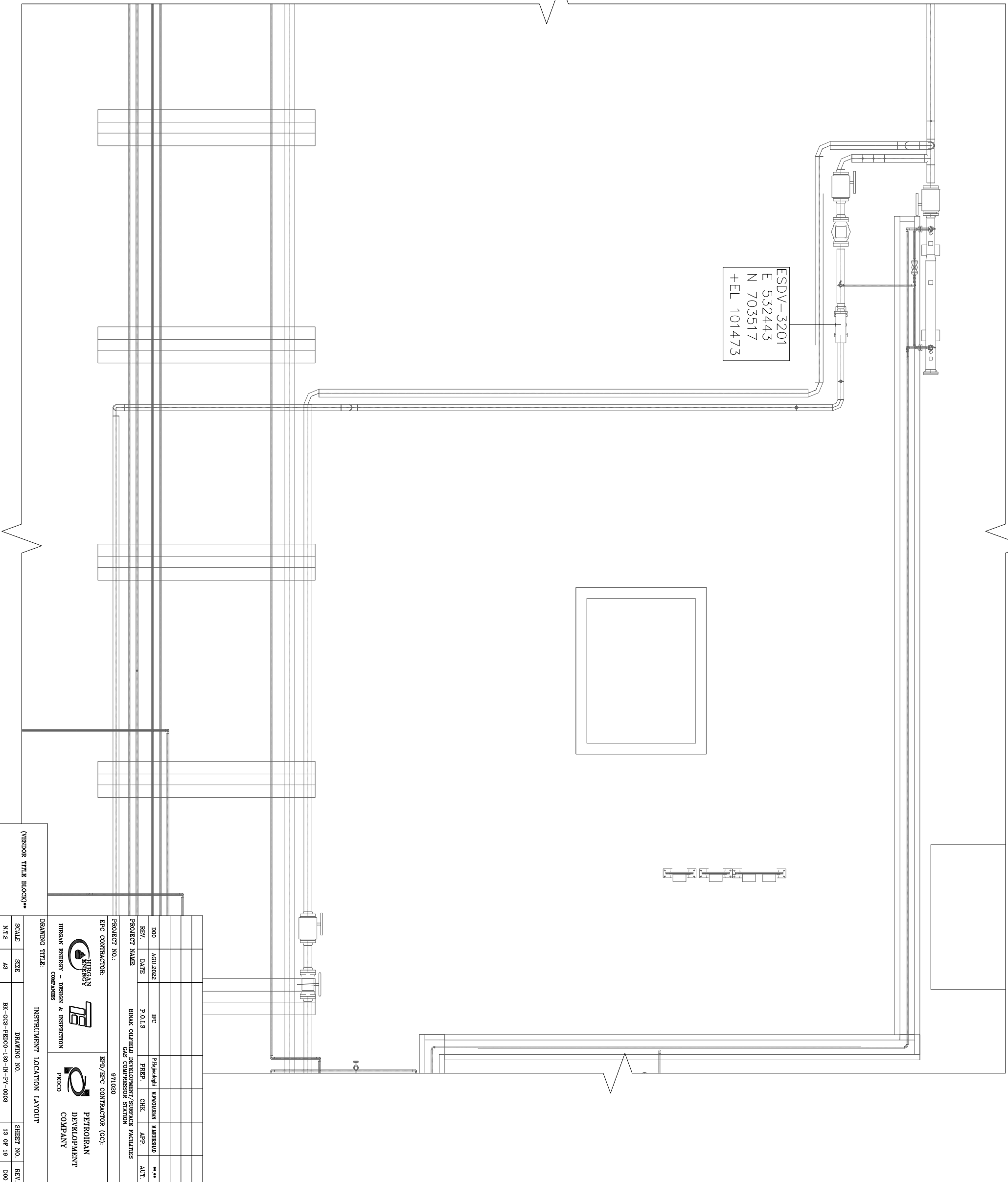

(VENDOR TITLE BLOCK)**

DOW		ACI/2022	IPC	Phase 1	MANAGEMENT	MANAGEMENT	MANAGEMENT	** **
REV.	DATE	FOCUS	PREP.	CHK.	APP.	APP.	APP.	ADT
PROJECT NAME: BINAK OILFIELD DEVELOPMENT/SURFACE FACILITIES								
PROJECT NO.: 971020								
EPC CONTRACTOR:				EPC CONTRACTOR (GC):				
HIRSAN ENERGY - DESIGN & INSPECTION				PETROBRAS DEVELOPMENT COMPANY				
DRAWING TITLE: INSTRUMENT LOCATION LAYOUT				DRAWING NO. 13 OF 19				
SCALE: A3		BR-GCS-PDCO-120-JP-0003		SHEET NO. 13 OF 19		REV. D00		NO CONSTRUCTION PERMITTED UNLESS DRAWING APPROVED
N.T.S								APPROVED FOR CONSTRUCTION BY: DATE:
								BUDGET REF: LOCATION SIZE CLASS SERIAL NO. 709998 01 OF 19 D00

REV.	DESCRIPTION	BY	DATE	BY	DATE
** **	*****	** **	*****	** **	*****
REV.	DESCRIPTION	BY	DATE	BY	DATE
*****	*****	** **	*****	** **	*****

THIS AREA

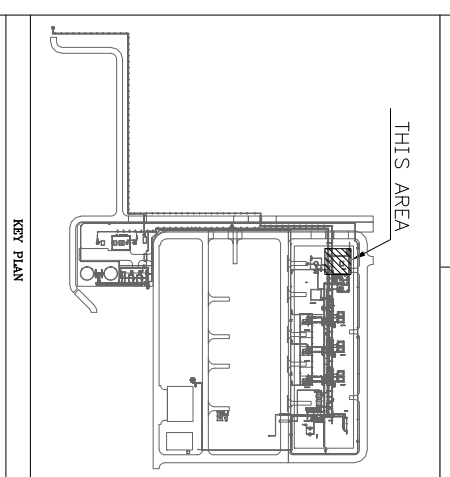

LEGEND

REFERENCE DRAWING

DRG. No.

NO CONSTRUCTION PERMITTED UNLESS DRAWING APPROVED	APPROVED FOR CONSTRUCTION BY: DATE:
BUDGET REF: LOCATION SIZE CLASS SERIAL NO. 709998	SHEET 01 OF 19
REV. D00	NO CONSTRUCTION PERMITTED UNLESS DRAWING APPROVED

NOTES

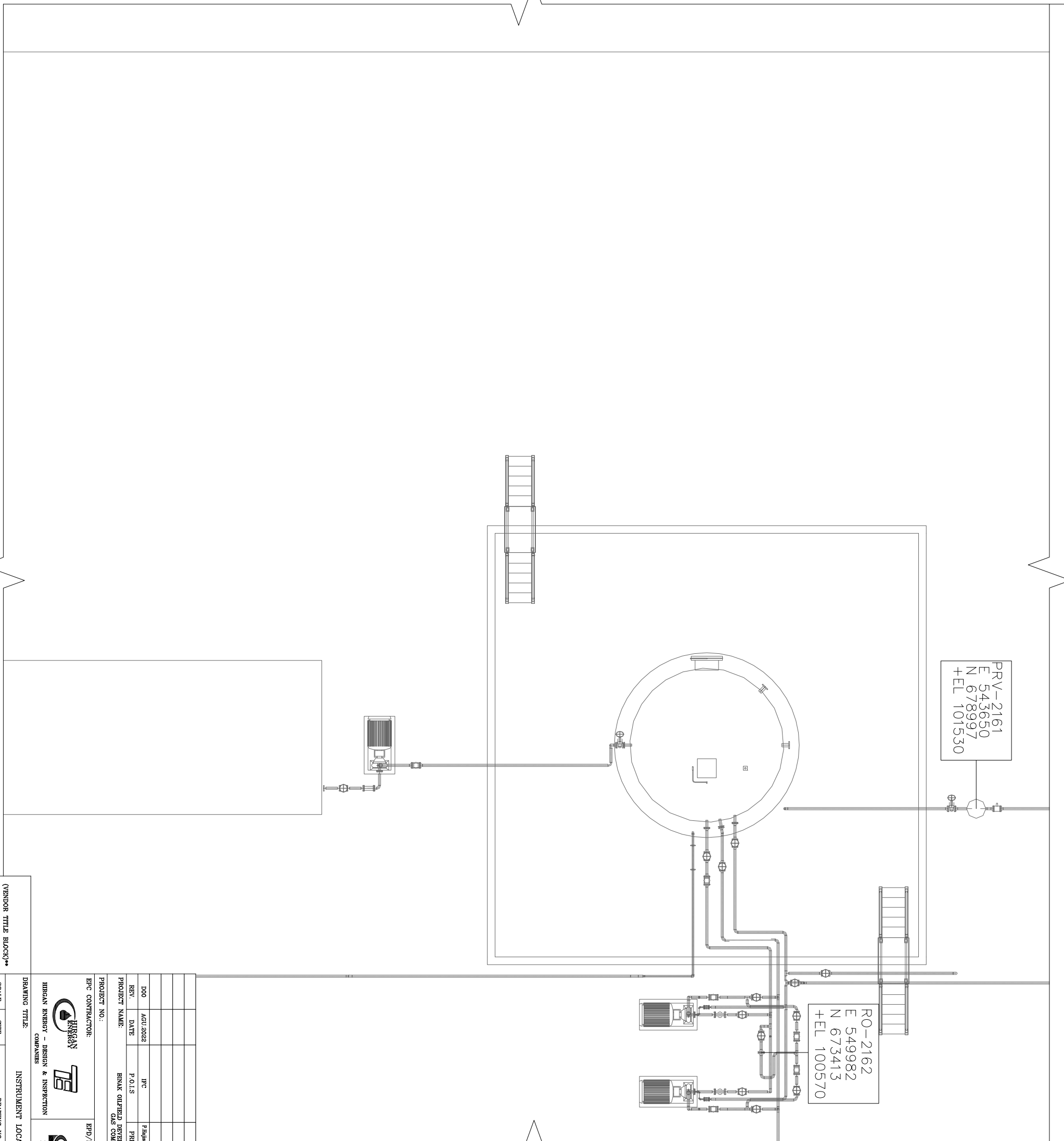
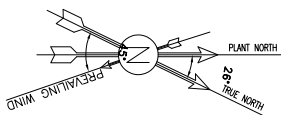

PRV-2161
E 543650
N 678997
+EL 101530

RO-2162
E 549982
N 673413
+EL 100570

NOTES

LEGEND

REFERENCE DRAWING

DRG. No.

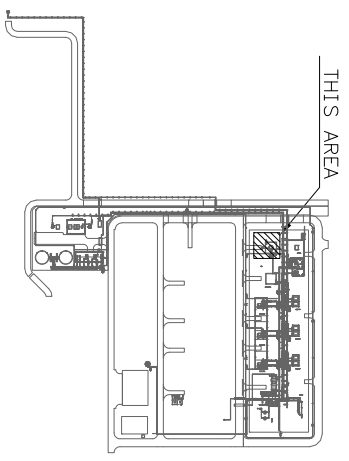

REV.	DATE	BY	DATE	DESCRIPTION
000	AC1/2022	FC		
REV.	DATE	FOUS	PREP.	CHK.
		PHILIPMAGHAI	MANAGEMENT	MANSOURI
			APP.	AUT.

NO CONSTRUCTION PERMITTED UNLESS DRAWING APPROVED

APPROVED FOR CONSTRUCTION BY: _____ DATE: _____

BUDGET REF. LOCATION SIZE CLASS SERIAL NO. SHEET REVISION

0-53-073-9184 F 2 J 709998 01 OF 19 D00

PROJECT NAME: BINAK OILFIELD DEVELOPMENT/SURFACE FACILITIES GAS COMPRESSOR STATION

PROJECT NO.: 971030

EPC CONTRACTOR: BHP/BJC CONTRACTOR (GC)

DESIGNER & INSPECTOR: HIRGAN ENERGY - DESIGN & INSPECTION

DEVELOPMENT COMPANY: PETROIRAN DEVELOPMENT COMPANY

SCALE: AS

DRAWING NO.: BR-GCS-PDCO-120-JL-PY-0003

SHEET NO.: 14 OF 19

REV.: D00

(VENDOR TITLE BLOCK)**

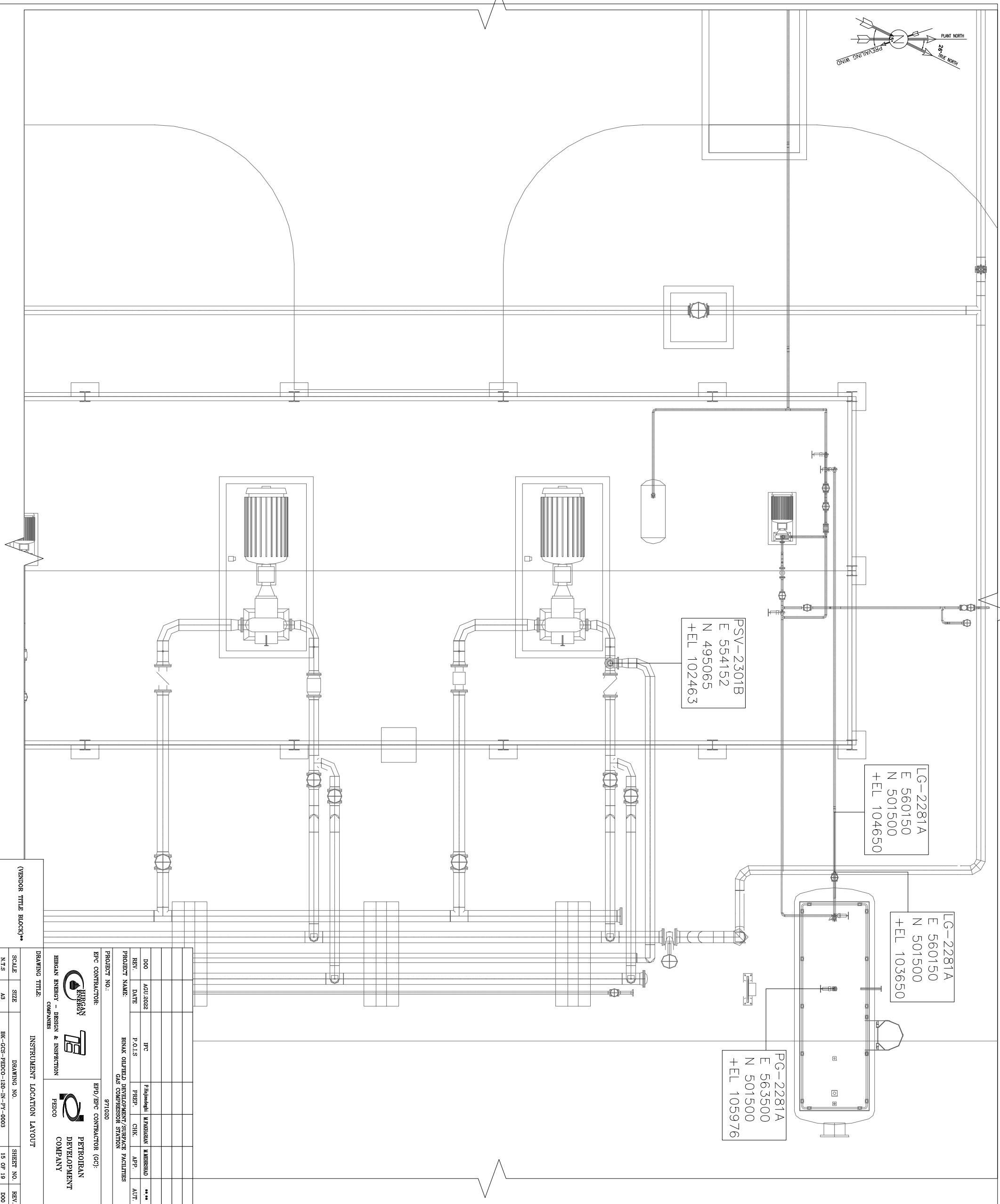
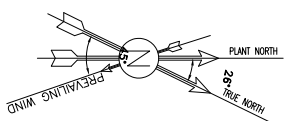

PSV-2301B
E 554152
N 495065
+EL 102463

LG-2281A
E 560150
N 501500
+EL 104650

LG-2281A
E 560150
N 501500
+EL 103650

PG-2281A
E 563500
N 501500
+EL 105976

NOTES

LEGEND

REFERENCE DRAWING

DRG. No.

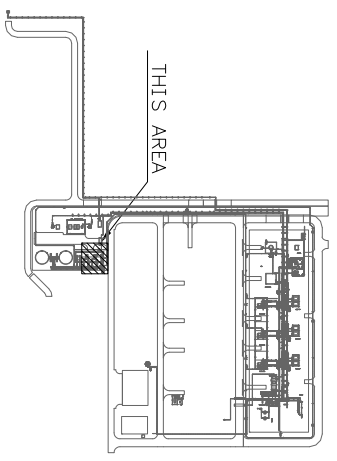

KEY PLAN

REV.	DATE	DESCRIPTION	BY	DATE	BY	DATE
000	01/2022	IFC	PHILIPMAGHJI	MURRAY	MURRAY	01/2022
001		FOR IS	PHILIPMAGHJI	CHK	APP	01/2022

NO CONSTRUCTION PERMITTED UNLESS DRAWING APPROVED
APPROVED FOR CONSTRUCTION BY: DATE:
BUDGET REF LOCATION SIZE CLASS SERIAL NO. SHEET REVISION
0-65-073-0184 F 2 J 709998 01 OF 19 D00

HIRSANY ENGINEERING & DESIGN
TE DESIGN & INSPECTION
PDICO EPC CONTRACTOR

PETROBRAS DEVELOPMENT COMPANY

HIRSANY ENGINEERING & DESIGN & INSPECTION
PDICO EPC CONTRACTOR (GC)
PETROBRAS DEVELOPMENT COMPANY
SURFACE FACILITIES
GAS COMPRESSOR STATION

PROJECT NAME: BINAK OILFIELD DEVELOPMENT/SURFACE FACILITIES
GAS COMPRESSOR STATION
PROJECT NO.: 971020

DATE SCALE DRAWING BY CHECKED BY PROJECT ENG.

(VENDOR TITLE BLOCK)**

SCALE	SIZE	DRAWING NO.	SHEET NO.	REV.
N.T.S	A3	BR-GCS-PDICO-120-IR-PY-0003	15 OF 19	D00

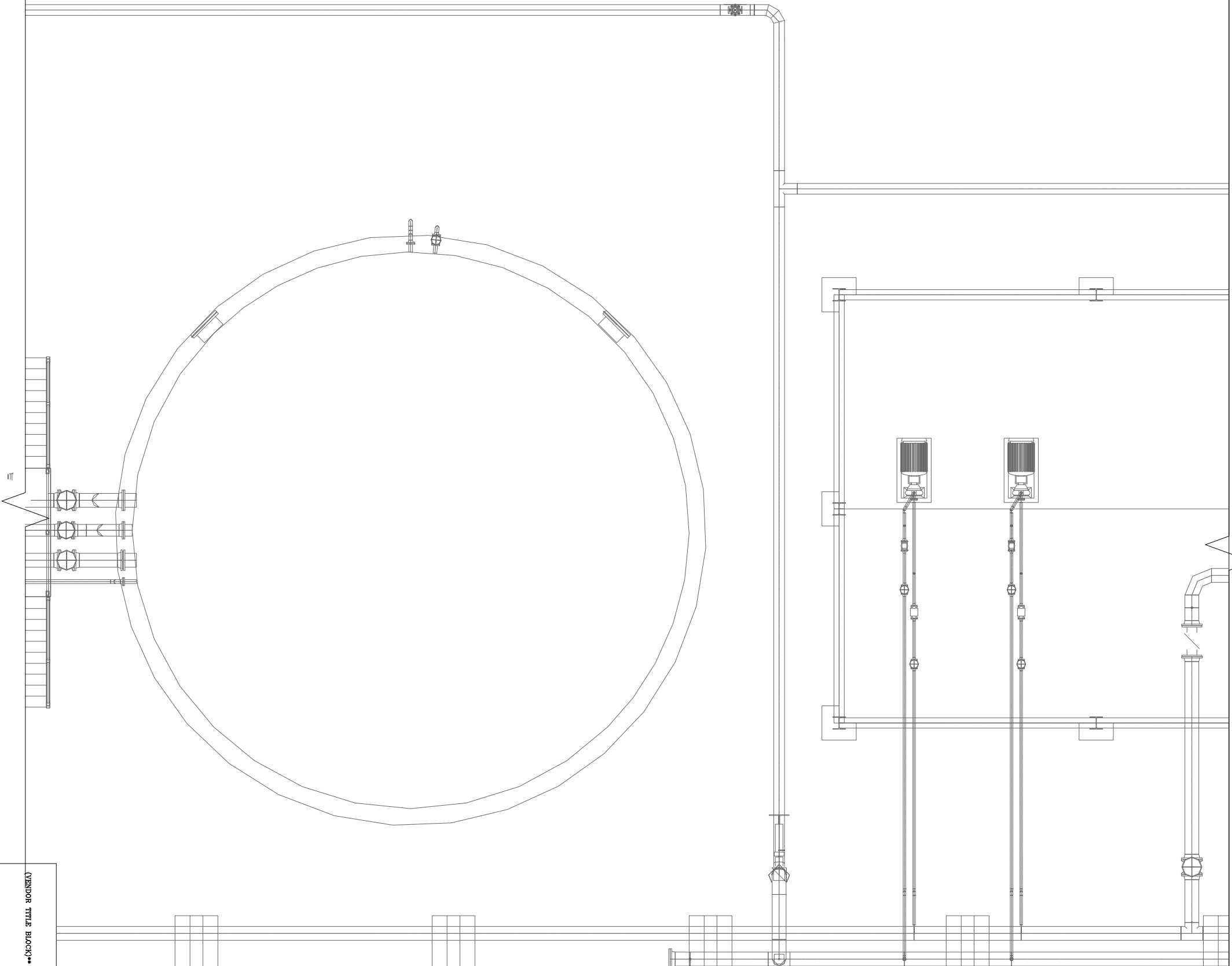
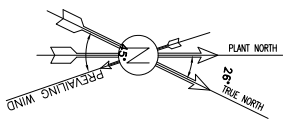

FI-2301
E 563214
N 479821
+EL 100662

NOTES

LEGEND

REFERENCE DRAWING

DRG. No.

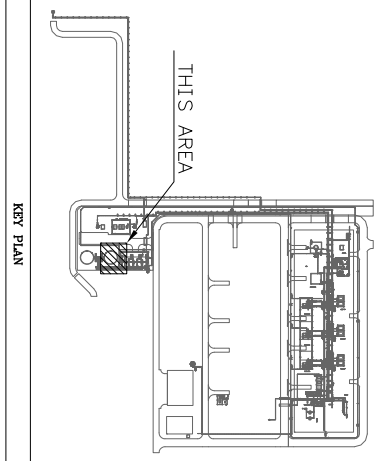

REV.	DATE	DESCRIPTION	BY	DATE	BY	DATE
000	01/2022	IFC	Philipmudhaji	MURSHID	MURSHID	** **
REV.	DATE	DESCRIPTION	BY	DATE	BY	DATE

PROJECT NAME: BINAK OILFIELD DEVELOPMENT/SURFACE FACILITIES GAS COMPRESSOR STATION

PROJECT NO.: 971020

EPC CONTRACTOR: EBD/EPIC CONTRACTOR (GC)

DESIGNER: HIRGAN ENERGY - DESIGN & INSPECTION

DEVELOPER: PETROBRAS DEVELOPMENT COMPANY

SCALE	SIZE	DRAWING NO.	SHEET NO.	REV.	BUDGET REF.	LOCATION SIZE CLASS	SERIAL NO.	SHEET	REVISION
N.T.S	A3	BR-GCS-PDCO-120-JR-PY-0003	16 OF 19	000	0-53-073-9184	F	2	J	709998

(VENDOR TITLE BLOCK)**

NO CONSTRUCTION PERMITTED UNLESS DRAWING APPROVED

APPROVED FOR CONSTRUCTION BY: DATE:

THE ORIGINAL AND ALL COPIES OF THIS DRAWING TOGETHER WITH THE COPYRIGHT THEREIN ARE THE SOLE PROPERTY OF N.I.S.O.C./ FIELDS

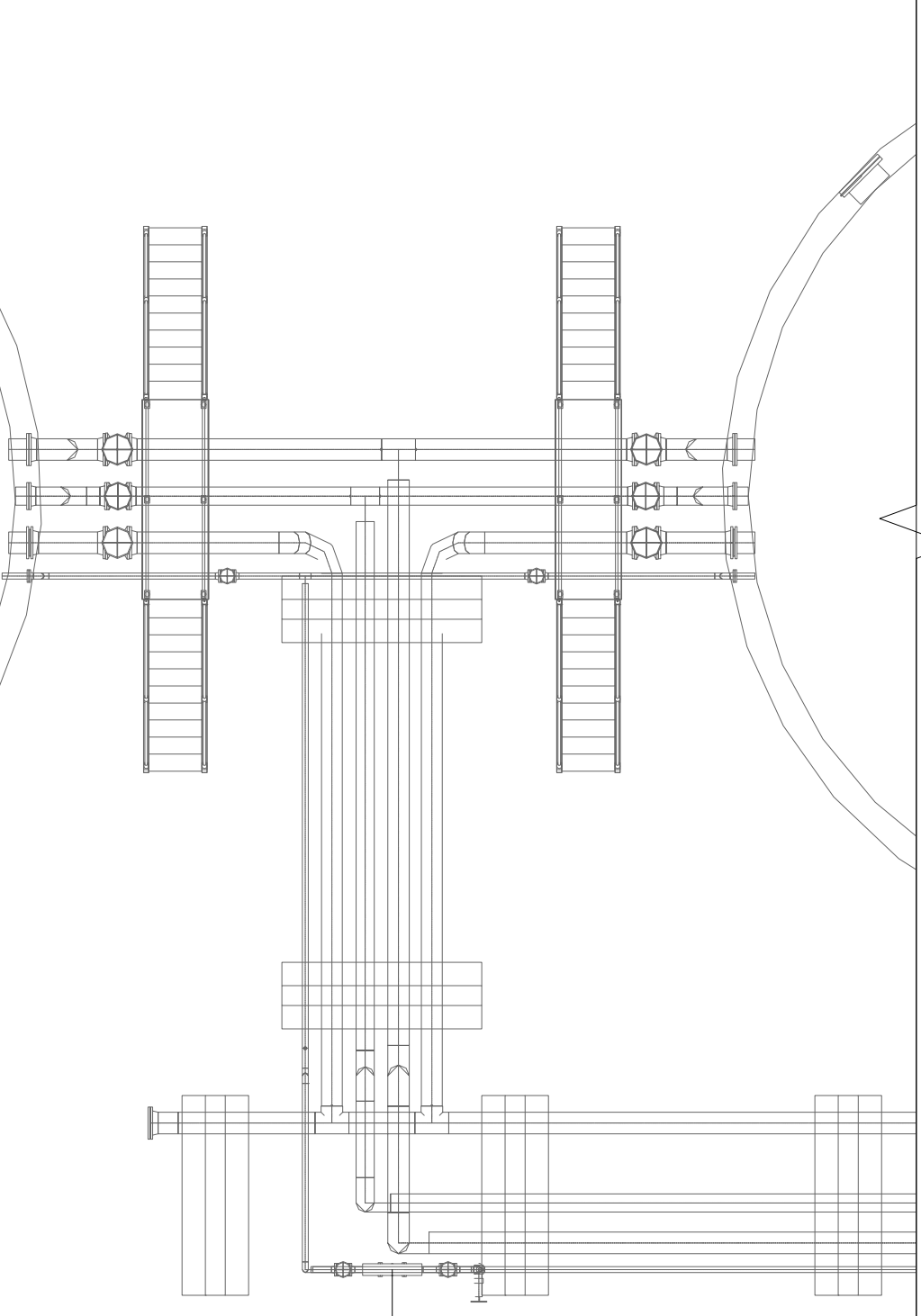
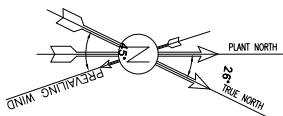

XV-2301
E 563615
N 452156
+EL 100545

NOTES

LEGEND

REFERENCE DRAWING

DRG. No.

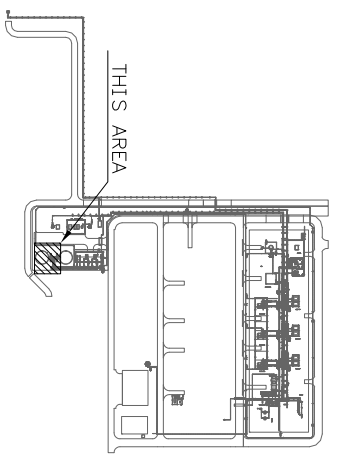

REV.	DATE	DESCRIPTION	CHECKED BY	DATE	APPR. DATE
000	01/2022	IFC	Philipmudhaji MURUMBAUDU		01/2022
001	01/2022	FOR IS	PREP. CRK. APP. AUT.		01/2022

PROJECT NAME: BINAK OILFIELD DEVELOPMENT/SURFACE FACILITIES GAS COMPRESSOR STATION
PROJECT NO.: 971020

EPC CONTRACTOR: HIRSHAN ENERGY - DESIGN & INSPECTION COMPANIES
EHP/EPC CONTRACTOR (GC): PETROBRAN DEVELOPMENT COMPANY

DRAWING TITLE: INSTRUMENT LOCATION LAYOUT
SCALE: A3
SHEET NO. 17 OF 19
REV. 000

NO CONSTRUCTION PERMITTED UNLESS DRAWING APPROVED FOR CONSTRUCTION BY: DATE: 01/19/2022

APPROVED FOR CONSTRUCTION BY: DATE: 01/19/2022

(VENDOR TITLE BLOCK)**

