



نگهداشت و افزایش تولید میدان نفتی بینک
سطح الارض

احداث ردیف تراکم گاز در ایستگاه جمع آوری بینک



شماره پیمان:

053 - 073 - 9184

PDMS Model Review Report (90%)

پروژه	بسته کاری	صادر کننده	تسهیلات	رشته	نوع مدرک	سریال	نسخه
BK	GCS	PEDCO	120	PI	RT	0005	D01

شماره صفحه: 1 از 13

طرح نگهداشت و افزایش تولید 27 مخزن

PDMS Model Review Report (90%)

نگهداشت و افزایش تولید میدان نفتی بینک

Rev.	Date	Purpose of Issue/Status	Prepared by:	Checked by:	Approved by:	CLIENT Approval
D01	FEB.2024	AFD	M.Noori	M.Fakharian	S.Faramarzpour	
D00	OCT.2023	IFC	M.Noori	M.Fakharian	S.Faramarzpour	

Class:2

CLIENT Doc. Number: F0Z-708909

Status:

IDC: Inter-Discipline Check
IFC: Issued For Comment
IFA: Issued For Approval
AFD: Approved For Design
AFC: Approved For Construction
AFP: Approved For Purchase
AFQ: Approved For Quotation
IFI: Issued For Information
AB-R: As-Built for CLIENT Review
AB-A: As-Built -Approved



نگهداشت و افزایش تولید میدان نفتی بینک
سطح الارض

احداث ردیف تراکم گاز در ایستگاه جمع آوری بینک



شماره پیمان:

053 - 073 - 9184

PDMS Model Review Report (90%)



نسخه	سریال	نوع مدرک	رشته	تسهیلات	صادر کننده	بسته کاری	پروژه
D01	0005	RT	PI	120	PEDCO	GCS	BK

شماره صفحه: 2 از 13

REVISION RECORD SHEET



PAGE	D00	D01	D02	D03	D04
1	X	X			
2	X	X			
3	X				
4	X				
5	X				
6	X				
7	X				
8	X				
9	X				
10	X				
11	X				
12	X				
13	X	X			
14					
15					
16					
17					
18					
19					
20					
21					
22					
23					
24					
25					
26					
27					
28					
29					
30					
31					
32					
33					
34					
35					
36					
37					
38					
39					
40					
41					
42					
43					
44					
45					
46					
47					
48					
49					
50					
51					
52					
53					
54					
55					
56					
57					
58					
59					
60					
61					
62					
63					
64					
65					

PAGE	D00	D01	D02	D03	D04
66					
67					
68					
69					
70					
71					
72					
73					
74					
75					
76					
77					
78					
79					
80					
81					
82					
83					
84					
85					
86					
87					
88					
89					
90					
91					
92					
93					
94					
95					
96					
97					
98					
99					
100					
101					
102					
103					
104					
105					
106					
107					
108					
109					
110					
111					
112					
113					
114					
115					
116					
117					
118					
119					
120					
121					
122					
123					
124					
125					
126					
127					
128					
129					
130					

 <p>NISOC</p>	<p>نگهداشت و افزایش تولید میدان نفتی بینک سطح الارض</p> <p>احداث ردیف تراکم گاز در ایستگاه جمع آوری بینک</p>																	
<p>شماره پیمان: 053 – 073 – 9184</p>	<p style="text-align: center;">PDMS Model Review Report (90%)</p> <table border="1" style="width: 100%; text-align: center;"> <tr> <td>پروژه</td> <td>بسته کاری</td> <td>صادر کننده</td> <td>تسهیلات</td> <td>رشته</td> <td>نوع مدرک</td> <td>سریال</td> <td>نسخه</td> </tr> <tr> <td>BK</td> <td>GCS</td> <td>PEDCO</td> <td>120</td> <td>PI</td> <td>RT</td> <td>0005</td> <td>D01</td> </tr> </table>	پروژه	بسته کاری	صادر کننده	تسهیلات	رشته	نوع مدرک	سریال	نسخه	BK	GCS	PEDCO	120	PI	RT	0005	D01	<p style="text-align: center;">شماره صفحه : 3 از 13</p>
پروژه	بسته کاری	صادر کننده	تسهیلات	رشته	نوع مدرک	سریال	نسخه											
BK	GCS	PEDCO	120	PI	RT	0005	D01											

CONTENTS

1.0	INTRODUCTION	4
2.0	SCOPE	4
3.0	NORMATIVE REFERENCES.....	5
3.1	THE PROJECT DOCUMENTS.....	5
3.2	ORDER OF PRECEDENCE	5
4.0	KEY OBJECTIVES.....	5
5.0	STATISTICS.....	5
6.0	DESCRIPTION AND CONCLUSIONS.....	6
7.0	ATTACHEMENT 1	13
8.0	ATTACHEMENT 2	13
9.0	ATTACHEMENT 3	13

 <p>NISOC</p>	<p>نگهداشت و افزایش تولید میدان نفتی بینک سطح الارض</p> <p>احداث ردیف تراکم گاز در ایستگاه جمع آوری بینک</p>																	
<p>شماره پیمان: 053 – 073 – 9184</p>	<p>PDMS Model Review Report (90%)</p> <table border="1" style="width: 100%; border-collapse: collapse;"> <tr> <td>پروژه</td> <td>بسته کاری</td> <td>صادر کننده</td> <td>تسهیلات</td> <td>رشته</td> <td>نوع مدرک</td> <td>سریال</td> <td>نسخه</td> </tr> <tr> <td>BK</td> <td>GCS</td> <td>PEDCO</td> <td>120</td> <td>PI</td> <td>RT</td> <td>0005</td> <td>D01</td> </tr> </table>	پروژه	بسته کاری	صادر کننده	تسهیلات	رشته	نوع مدرک	سریال	نسخه	BK	GCS	PEDCO	120	PI	RT	0005	D01	<p>شماره صفحه : 4 از 13</p>
پروژه	بسته کاری	صادر کننده	تسهیلات	رشته	نوع مدرک	سریال	نسخه											
BK	GCS	PEDCO	120	PI	RT	0005	D01											

1.0 INTRODUCTION

Binak oilfield in Bushehr province is a part of the southern oilfields of Iran, is located 20 km northwest of Genaveh city.

With the aim of increasing production of oil from Binak oilfield, an EPC/EPD Project has been defined by NIOC/NISOC and awarded to Petro Iran Development Company (PEDCO). Also PEDCO (as General Contractor) has assigned the EPC-packages of the Project to "Hirgan Energy - Design and Inspection" JV.

As a part of the Project, a New Gas Compressor Station (adjacent to existing Binak GCS) shall be constructed to gather of 15 MMSCFD (approx.) associated gases and compress & transfer them to Siahmakan GIS.



GENERAL DEFINITION

The following terms shall be used in this document.

CLIENT:	National Iranian South Oilfields Company (NISOC)
PROJECT:	Binak Oilfield Development – Surface Facilities; New Gas Compressor Station
EPD/EPC CONTRACTOR (GC):	Petro Iran Development Company (PEDCO)
EPC CONTRACTOR:	Joint Venture of : Hirgan Energy – Design & Inspection (D&I) Companies
VENDOR:	The firm or person who will fabricate the equipment or material.
EXECUTOR:	Executor is the party which carries out all or part of construction and/or commissioning for the project.
THIRD PARTY INSPECTOR (TPI):	The firm appointed by EPD/EPC CONTRACTOR (GC) and approved by CLIENT (in writing) for the inspection of goods.
SHALL:	Is used where a provision is mandatory.
SHOULD:	Is used where a provision is advisory only.
WILL:	Is normally used in connection with the action by CLIENT rather than by an EPC/EPD CONTRACTOR, supplier or VENDOR.
MAY:	Is used where a provision is completely discretionary.

2.0 SCOPE

This document presents all raised issues and made decisions during 90% model review session of

	<p>نگهداشت و افزایش تولید میدان نفتی بینک سطح الارض</p> <p>احداث ردیف تراکم گاز در ایستگاه جمع آوری بینک</p>																	
<p>شماره پیمان: 053 – 073 – 9184</p>	<p>PDMS Model Review Report (90%)</p> <table border="1" style="width: 100%; border-collapse: collapse;"> <tr> <td style="width: 10%;">پروژه</td> <td style="width: 10%;">بسته کاری</td> <td style="width: 10%;">صادر کننده</td> <td style="width: 10%;">تسهیلات</td> <td style="width: 10%;">رشته</td> <td style="width: 10%;">نوع مدرک</td> <td style="width: 10%;">سریال</td> <td style="width: 10%;">نسخه</td> </tr> <tr> <td>BK</td> <td>GCS</td> <td>PEDCO</td> <td>120</td> <td>PI</td> <td>RT</td> <td>0005</td> <td>D01</td> </tr> </table>	پروژه	بسته کاری	صادر کننده	تسهیلات	رشته	نوع مدرک	سریال	نسخه	BK	GCS	PEDCO	120	PI	RT	0005	D01	<p>شماره صفحه : 5 از 13</p>
پروژه	بسته کاری	صادر کننده	تسهیلات	رشته	نوع مدرک	سریال	نسخه											
BK	GCS	PEDCO	120	PI	RT	0005	D01											

PROJECT which should be followed and performed during continuation of PROJECT.

3.0 NORMATIVE REFERENCES

3.1 The Project Documents

- BK-GNRAL-PEDCO-000-PI-PR-0001 3D-Model (PDMS) Review Procedure

3.2 Order of Precedence

In case of any conflict between the contents of this document or any discrepancy between this document and other project documents or reference standards, this issue must be reported to the CLIENT. The final decision in this situation will be made by CLIENT.

4.0 KEY OBJECTIVES

The purpose of 90% Model Review is to confirm that all comments raised in the previous review have properly been followed and updated. In principle, re-study of the comments raised in previous model reviews should not be executed as far as such comments have properly been followed.



The model minimum content for the 90% model review shall be:

- Actions resulting from 60% model review.
- Vendor data incorporation and modifying relevant lines to adjust for equipment final condition.
- Remaining piping (line sizes below 2") with insulation and steam tracing information completed.
- Remaining platforms, stairs, ladders, hoisting beams, davits, limited hand rails/ladder cages.
- The model will be substantially completed including instrument/F&G and electrical equipment and cable tray routes.

5.0 STATISTICS

The followings indicate the number of modeled major items which were reviewed during 60% model review:

- Number of modeled equipment: 68
- Number of modeled A/G and U/G Lines: 470
- Number of hydrant and monitor: 16
- Number of modeled shelter, structure and building: 14
- Electrical main trench
- Instrument main cable trench
- Instrument junction boxes

	<p>نگهداشت و افزایش تولید میدان نفتی بینک سطح الارض</p> <p>احداث ردیف تراکم گاز در ایستگاه جمع آوری بینک</p>																	
<p>شماره پیمان: 053 – 073 – 9184</p>	<p style="text-align: center;">PDMS Model Review Report (90%)</p> <table border="1" style="width: 100%; text-align: center;"> <tr> <td>پروژه</td> <td>بسته کاری</td> <td>صادر کننده</td> <td>تسهیلات</td> <td>رشته</td> <td>نوع مدرک</td> <td>سریال</td> <td>نسخه</td> </tr> <tr> <td>BK</td> <td>GCS</td> <td>PEDCO</td> <td>120</td> <td>PI</td> <td>RT</td> <td>0005</td> <td>D01</td> </tr> </table>	پروژه	بسته کاری	صادر کننده	تسهیلات	رشته	نوع مدرک	سریال	نسخه	BK	GCS	PEDCO	120	PI	RT	0005	D01	<p style="text-align: center;">شماره صفحه : 6 از 13</p>
پروژه	بسته کاری	صادر کننده	تسهیلات	رشته	نوع مدرک	سریال	نسخه											
BK	GCS	PEDCO	120	PI	RT	0005	D01											

6.0 DESCRIPTION AND CONCLUSIONS



The 90% model review for “Binak Oilfield Development – Surface Facilities; New Gas Compressor Station” was held with representatives of CLIENT, EPD/EPC CONTRACTOR (GC) and EPC CONTRACTOR, on 1402/07/24. The subjects of discussion for the meeting were organized and considered based on the following issues:

- Re-study of the comments raised in 60%
- General layout and arrangement,
- Operation access rooms,
- Maintenance requirements,
- Installing location for instruments, platforms, and access to instruments,
- Lineup of process lines.
- Instrument cable route and junction boxes location

It was stated that following items should be checked and corrected during 90% modeling and would be reviewed in 90% model review meeting:

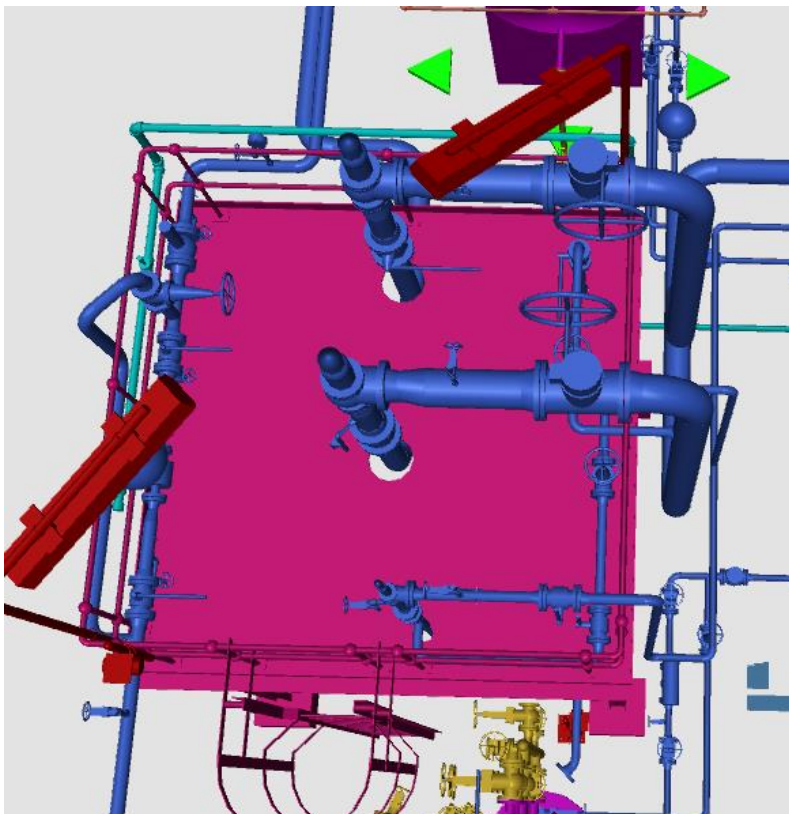
- 6.1** For better access to valves and psv flanges, Platforms shall be extended. This item should be checked for all platforms and if required applied if required. For example, v-2105 platform shall be modified by moving the valve or extending of platform.



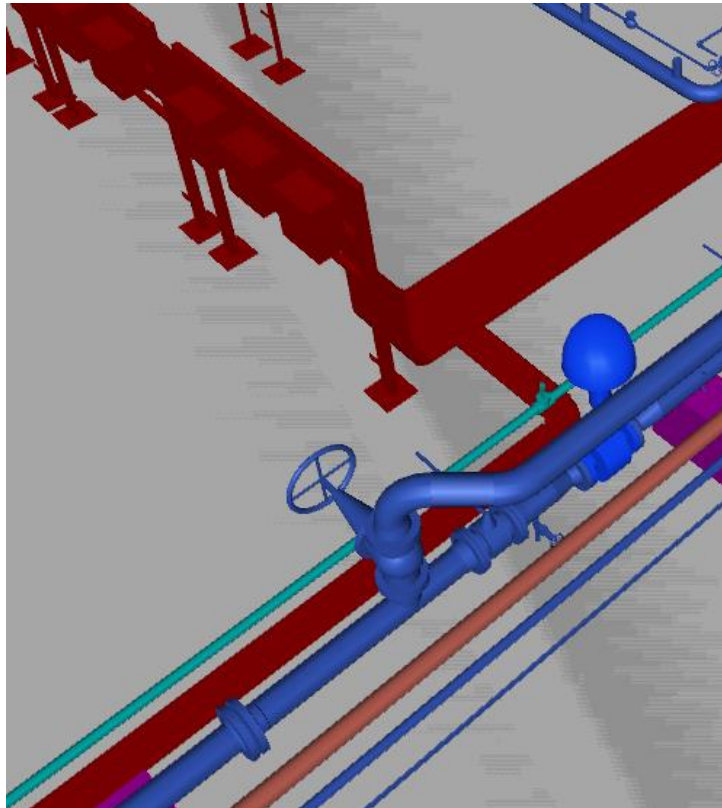

	<p>نگهداشت و افزایش تولید میدان نفتی بینک سطح الارض</p> <p>احداث ردیف تراکم گاز در ایستگاه جمع آوری بینک</p>																	
<p>شماره پیمان: 053 - 073 - 9184</p>	<p style="text-align: center;">PDMS Model Review Report (90%)</p> <table border="1" style="width: 100%; text-align: center;"> <tr> <td>پروژه</td> <td>بسته کاری</td> <td>صادر کننده</td> <td>تسهیلات</td> <td>رشته</td> <td>نوع مدرک</td> <td>سریال</td> <td>نسخه</td> </tr> <tr> <td>BK</td> <td>GCS</td> <td>PEDCO</td> <td>120</td> <td>PI</td> <td>RT</td> <td>0005</td> <td>D01</td> </tr> </table>	پروژه	بسته کاری	صادر کننده	تسهیلات	رشته	نوع مدرک	سریال	نسخه	BK	GCS	PEDCO	120	PI	RT	0005	D01	<p style="text-align: center;">شماره صفحه : 7 از 13</p>
پروژه	بسته کاری	صادر کننده	تسهیلات	رشته	نوع مدرک	سریال	نسخه											
BK	GCS	PEDCO	120	PI	RT	0005	D01											

- 6.2** Hand wheel of manual valve which is located before FCV-2101 shall be rotated 180 degrees. (To have more distance of hand wheel from JB)

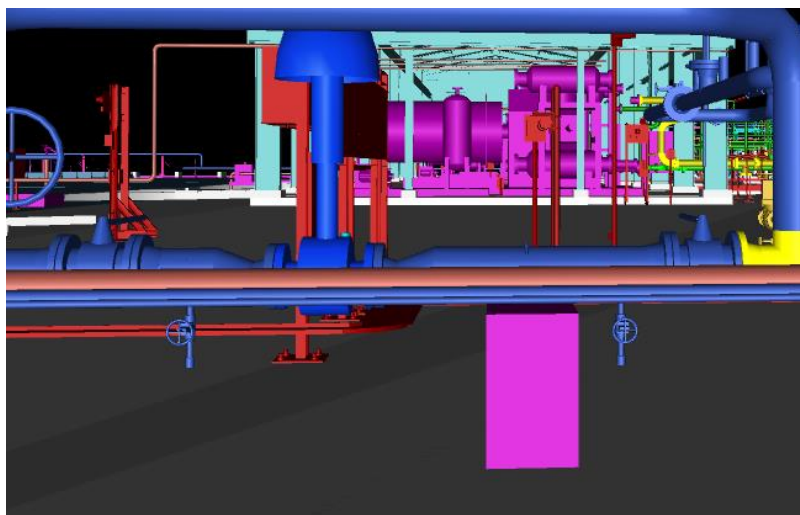

- 6.3** All drain valves shall be installed at elevation higher than the closed drain header. The route of connection to CDH header shall be finalized at site.



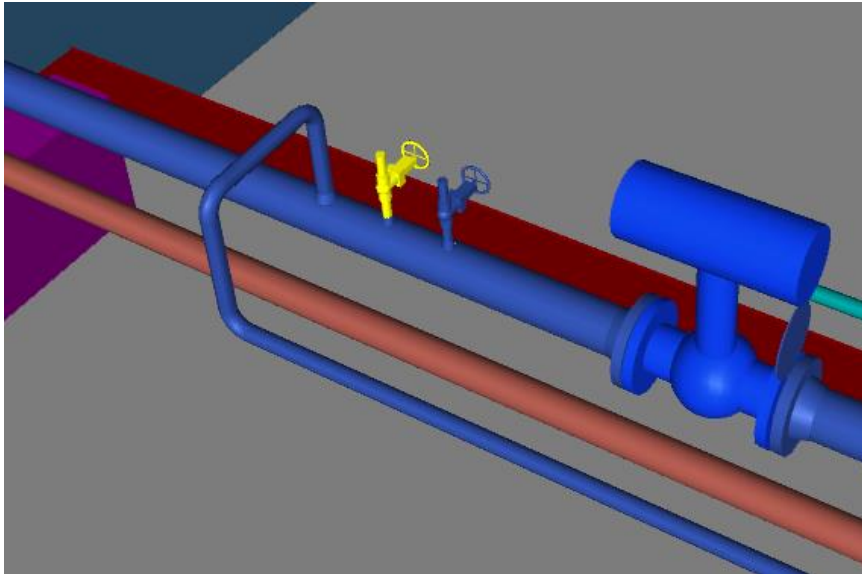

 <p>NISOC</p>	<p>نگهداشت و افزایش تولید میدان نفتی بینک سطح الارض</p> <p>احداث ردیف تراکم گاز در ایستگاه جمع آوری بینک</p>																	
<p>شماره پیمان: 053 - 073 - 9184</p>	<p style="text-align: center;">PDMS Model Review Report (90%)</p> <table border="1" style="width: 100%; text-align: center;"> <tr> <td>پروژه</td> <td>بسته کاری</td> <td>صادر کننده</td> <td>تسهیلات</td> <td>رشته</td> <td>نوع مدرک</td> <td>سریال</td> <td>نسخه</td> </tr> <tr> <td>BK</td> <td>GCS</td> <td>PEDCO</td> <td>120</td> <td>PI</td> <td>RT</td> <td>0005</td> <td>D01</td> </tr> </table>	پروژه	بسته کاری	صادر کننده	تسهیلات	رشته	نوع مدرک	سریال	نسخه	BK	GCS	PEDCO	120	PI	RT	0005	D01	<p>شماره صفحه : 8 از 13</p>
پروژه	بسته کاری	صادر کننده	تسهیلات	رشته	نوع مدرک	سریال	نسخه											
BK	GCS	PEDCO	120	PI	RT	0005	D01											

6.4 Details of sampling connection shall be illustrated in 3d model.

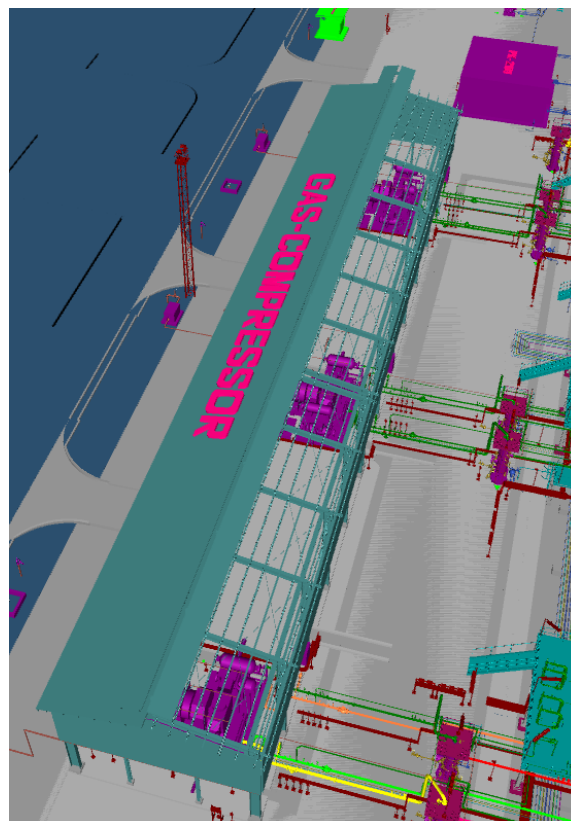

6.5 3D model of gas compressor package and dehydration package will be finalized after related 3d model meeting.



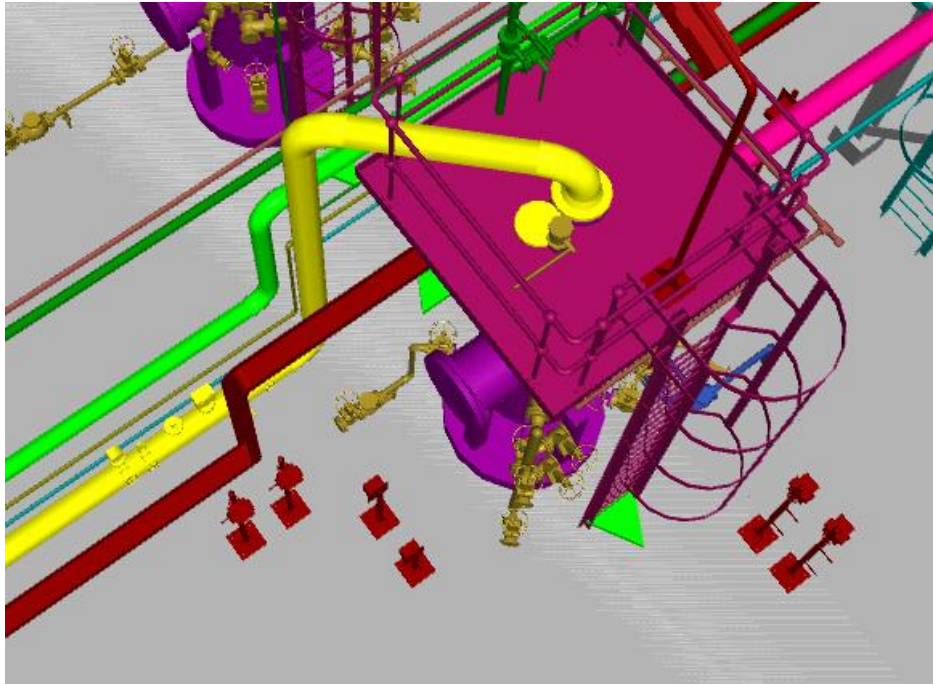

 <p>NISOC</p>	<p>نگهداشت و افزایش تولید میدان نفتی بینک سطح الارض</p> <p>احداث ردیف تراکم گاز در ایستگاه جمع آوری بینک</p>																	
<p>شماره پیمان: 053 - 073 - 9184</p>	<p style="text-align: center;">PDMS Model Review Report (90%)</p> <table border="1" style="width: 100%; text-align: center;"> <tr> <td>پروژه</td> <td>بسته کاری</td> <td>صادر کننده</td> <td>تسهیلات</td> <td>رشته</td> <td>نوع مدرک</td> <td>سریال</td> <td>نسخه</td> </tr> <tr> <td>BK</td> <td>GCS</td> <td>PEDCO</td> <td>120</td> <td>PI</td> <td>RT</td> <td>0005</td> <td>D01</td> </tr> </table>	پروژه	بسته کاری	صادر کننده	تسهیلات	رشته	نوع مدرک	سریال	نسخه	BK	GCS	PEDCO	120	PI	RT	0005	D01	<p>شماره صفحه : 9 از 13</p>
پروژه	بسته کاری	صادر کننده	تسهیلات	رشته	نوع مدرک	سریال	نسخه											
BK	GCS	PEDCO	120	PI	RT	0005	D01											

6.6 A Removable Spool shall be added on inlet line of V-2101 (A/B/C).

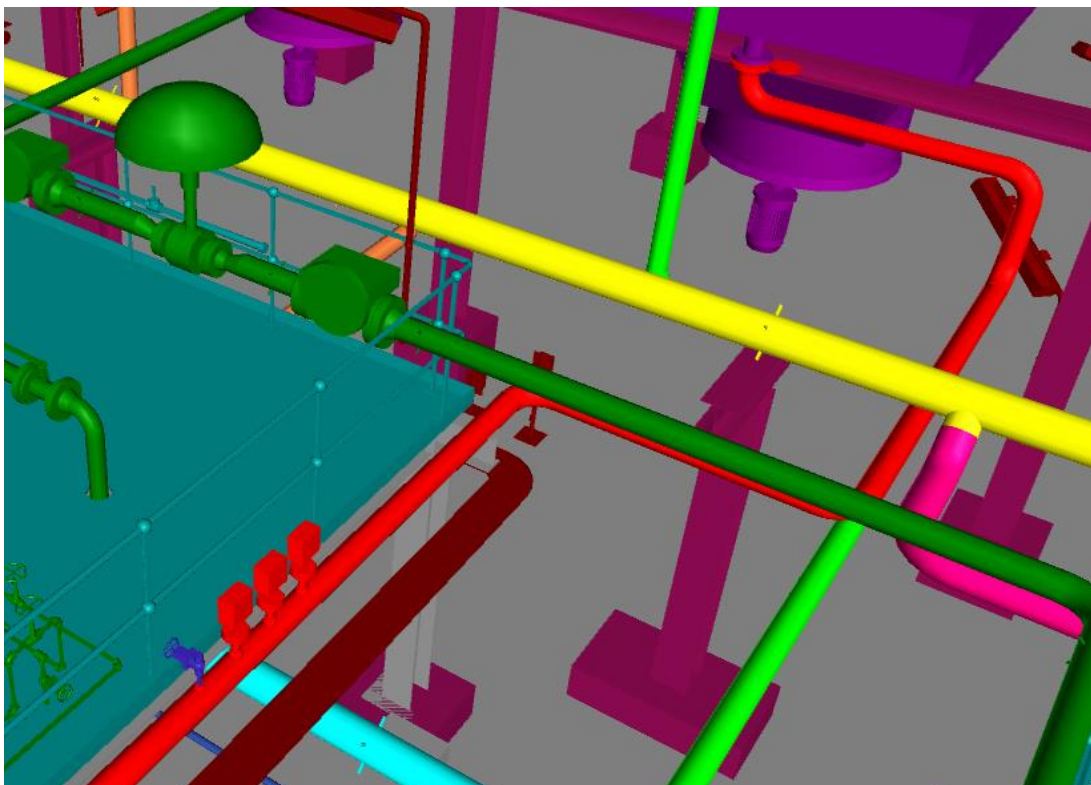

6.7 All instrument branch of gas cooler outlet line shall be moved to near of related platform.





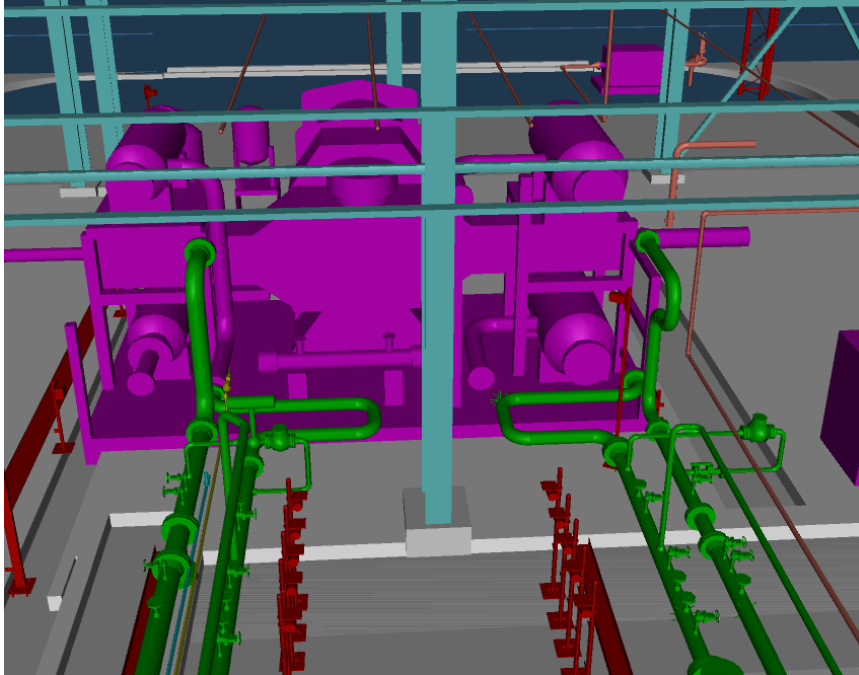

 <p>NISOC</p>	<p>نگهداشت و افزایش تولید میدان نفتی بینک سطح الارض</p> <p>احداث ردیف تراکم گاز در ایستگاه جمع آوری بینک</p>																	
<p>شماره پیمان: 053-073-9184</p>	<p style="text-align: center;">PDMS Model Review Report (90%)</p> <table border="1" style="width: 100%; text-align: center;"> <tr> <td>پروژه</td> <td>بسته کاری</td> <td>صادر کننده</td> <td>تسهیلات</td> <td>رشته</td> <td>نوع مدرک</td> <td>سریال</td> <td>نسخه</td> </tr> <tr> <td>BK</td> <td>GCS</td> <td>PEDCO</td> <td>120</td> <td>PI</td> <td>RT</td> <td>0005</td> <td>D01</td> </tr> </table>	پروژه	بسته کاری	صادر کننده	تسهیلات	رشته	نوع مدرک	سریال	نسخه	BK	GCS	PEDCO	120	PI	RT	0005	D01	<p>شماره صفحه : 10 از 13</p>
پروژه	بسته کاری	صادر کننده	تسهیلات	رشته	نوع مدرک	سریال	نسخه											
BK	GCS	PEDCO	120	PI	RT	0005	D01											

6.8 Client suggestion about removing of expansion loop which located on inlet line of gas compressors shall be checked.

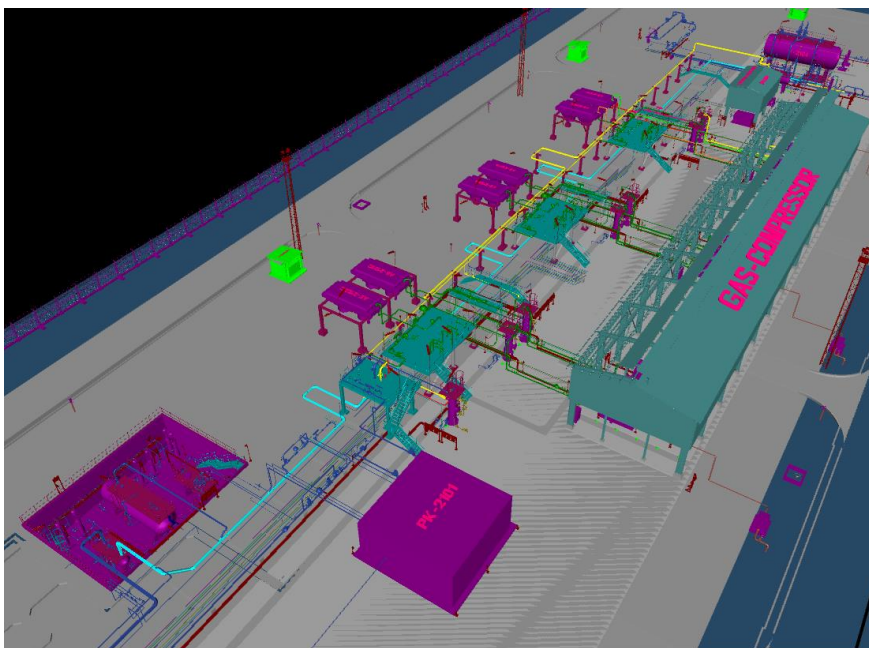

6.9 All hydrostatic test vent and drain shall be added to 3D model.



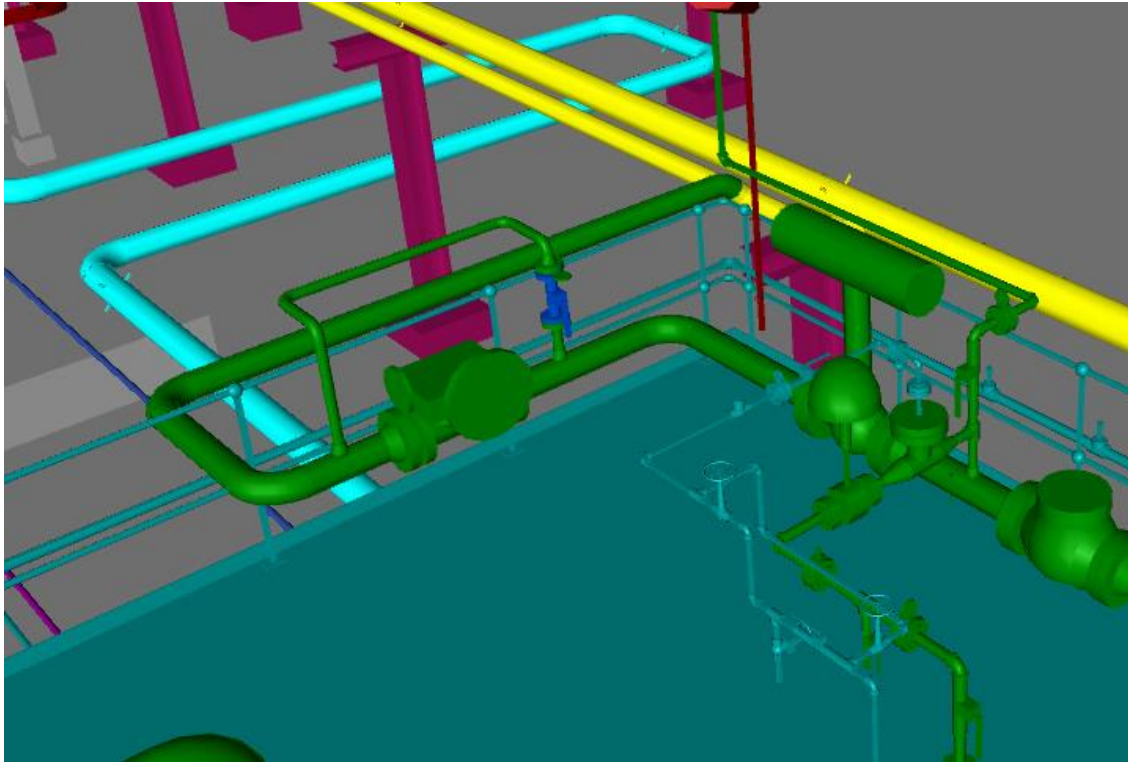

 <p>NISOC</p>	<p>نگهداشت و افزایش تولید میدان نفتی بینک سطح الارض</p> <p>احداث ردیف تراکم گاز در ایستگاه جمع آوری بینک</p>	 																
<p>شماره پیمان: 053 - 073 - 9184</p>	<p style="text-align: center;">PDMS Model Review Report (90%)</p> <table border="1" style="width: 100%; text-align: center;"> <tr> <td>پروژه</td> <td>بسته کاری</td> <td>صادر کننده</td> <td>تسهیلات</td> <td>رشته</td> <td>نوع مدرک</td> <td>سریال</td> <td>نسخه</td> </tr> <tr> <td>BK</td> <td>GCS</td> <td>PEDCO</td> <td>120</td> <td>PI</td> <td>RT</td> <td>0005</td> <td>D01</td> </tr> </table>	پروژه	بسته کاری	صادر کننده	تسهیلات	رشته	نوع مدرک	سریال	نسخه	BK	GCS	PEDCO	120	PI	RT	0005	D01	<p>شماره صفحه : 11 از 13</p>
پروژه	بسته کاری	صادر کننده	تسهیلات	رشته	نوع مدرک	سریال	نسخه											
BK	GCS	PEDCO	120	PI	RT	0005	D01											

6.10 The requirement to have 2" manual valve on outlet line of gas cooler shall be checked

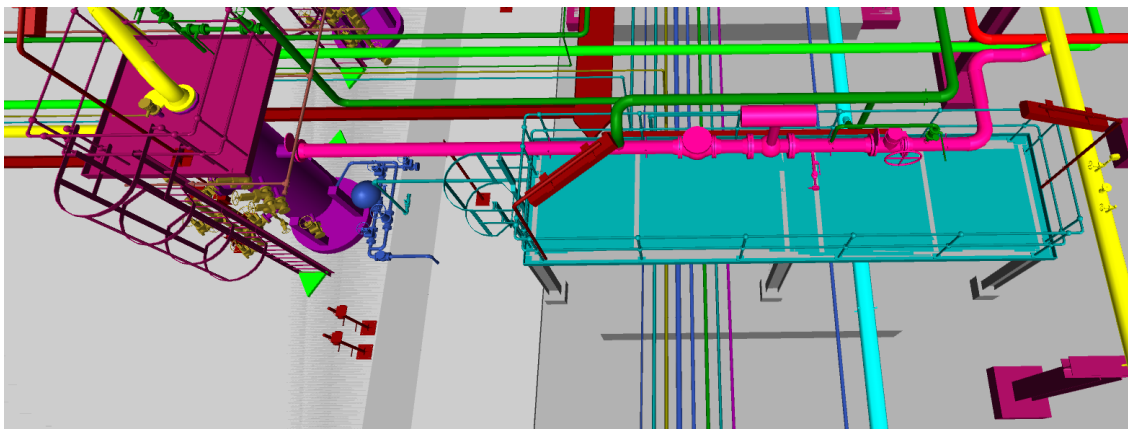

6.11 Client suggestion about requirement of adding balance valve, PIT and purge item for inlet line of V-2101A/B/C shall be checked by vendor.



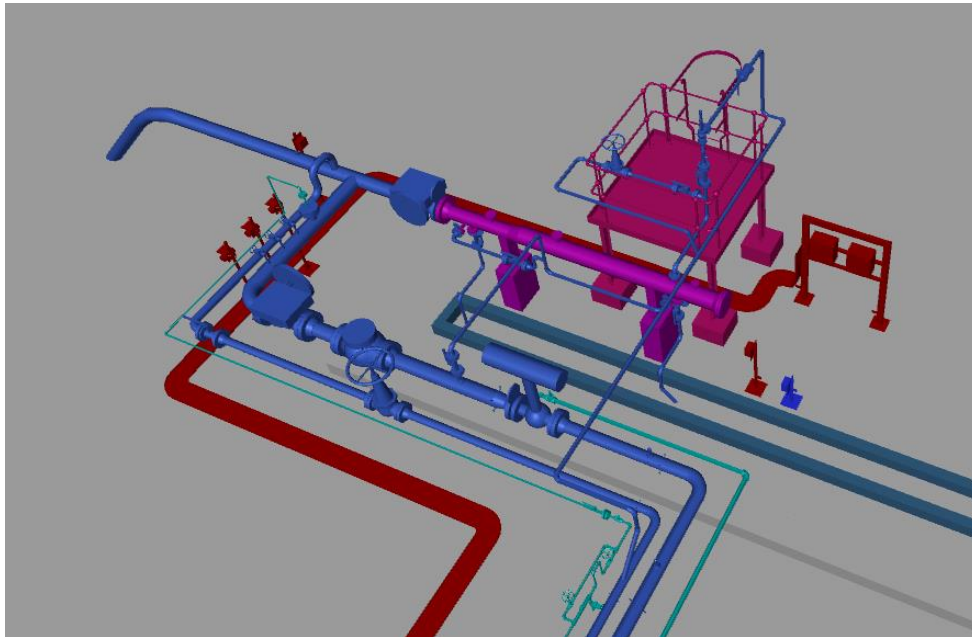

 <p>NISOC</p>	<p>نگهداشت و افزایش تولید میدان نفتی بینک سطح الارض</p> <p>احداث ردیف تراکم گاز در ایستگاه جمع آوری بینک</p>																	
<p>شماره پیمان: 053 - 073 - 9184</p>	<p style="text-align: center;">PDMS Model Review Report (90%)</p> <table border="1" style="width: 100%; text-align: center;"> <tr> <td>پروژه</td> <td>بسته کاری</td> <td>صادر کننده</td> <td>تسهیلات</td> <td>رشته</td> <td>نوع مدرک</td> <td>سریال</td> <td>نسخه</td> </tr> <tr> <td>BK</td> <td>GCS</td> <td>PEDCO</td> <td>120</td> <td>PI</td> <td>RT</td> <td>0005</td> <td>D01</td> </tr> </table>	پروژه	بسته کاری	صادر کننده	تسهیلات	رشته	نوع مدرک	سریال	نسخه	BK	GCS	PEDCO	120	PI	RT	0005	D01	<p style="text-align: center;">شماره صفحه : 12 از 13</p>
پروژه	بسته کاری	صادر کننده	تسهیلات	رشته	نوع مدرک	سریال	نسخه											
BK	GCS	PEDCO	120	PI	RT	0005	D01											

6.12 Location of FGD-6003 and TGD-6003 shall be revised and access area for PR-2002 shall be provided

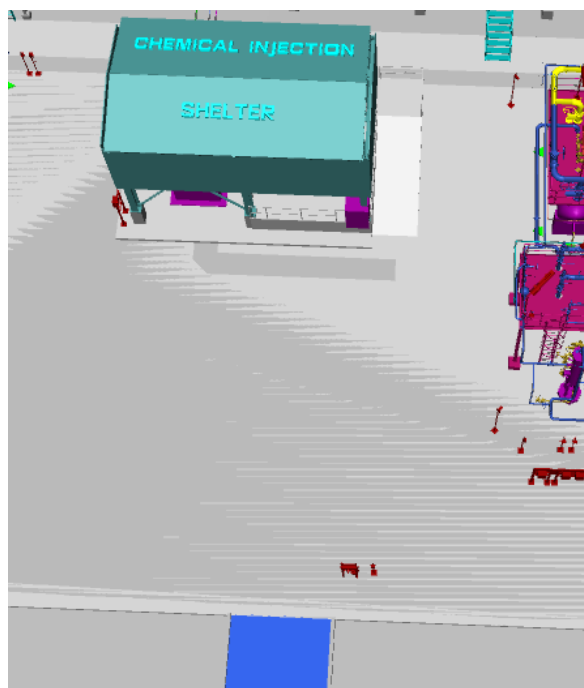

6.13 HN-3001 and MAC-3001 shall be moved from access way of chemical shelter and moved to the side of the road.



	<p>نگهداشت و افزایش تولید میدان نفتی بینک سطح الارض</p> <p>احداث ردیف تراکم گاز در ایستگاه جمع آوری بینک</p>																	
<p>شماره پیمان: 053-073-9184</p>	<p style="text-align: center;">PDMS Model Review Report (90%)</p> <table border="1" style="width: 100%; text-align: center;"> <thead> <tr> <th>پروژه</th> <th>بسته کاری</th> <th>صادر کننده</th> <th>تسهیلات</th> <th>رشته</th> <th>نوع مدرک</th> <th>سریال</th> <th>نسخه</th> </tr> </thead> <tbody> <tr> <td>BK</td> <td>GCS</td> <td>PEDCO</td> <td>120</td> <td>PI</td> <td>RT</td> <td>0005</td> <td>D01</td> </tr> </tbody> </table>	پروژه	بسته کاری	صادر کننده	تسهیلات	رشته	نوع مدرک	سریال	نسخه	BK	GCS	PEDCO	120	PI	RT	0005	D01	<p>شماره صفحه : 13 از 13</p>
پروژه	بسته کاری	صادر کننده	تسهیلات	رشته	نوع مدرک	سریال	نسخه											
BK	GCS	PEDCO	120	PI	RT	0005	D01											

6.14 Sunshade shall be considered to condensate pumps (P-2101A/B)

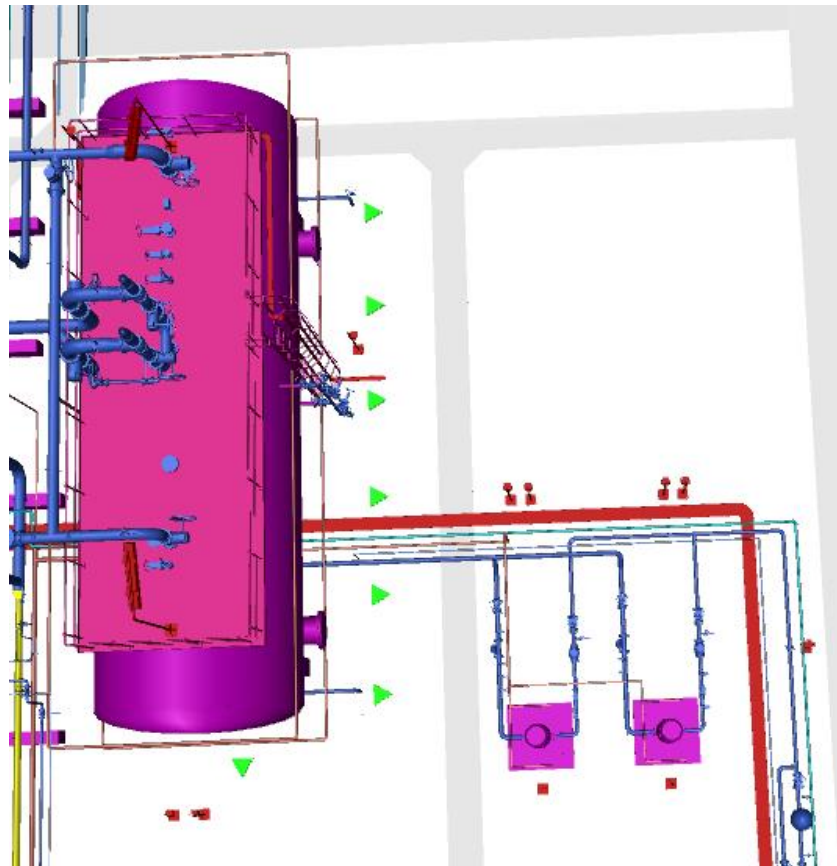

6.15 Instrument and electrical trench shall be revised due to client suggestion which is based on firefighting pumps power supply system.

6.16 3D model of Instrument and electrical trench shall be revised after overall cable route of instrument and electrical are finalized.

7.0 ATTACHEMENT 1

8.0 ATTACHEMENT 2

9.0 ATTACHEMENT 3